

Fast Recovery Single Diode Modules
50 Amperes/600-1200 Volts

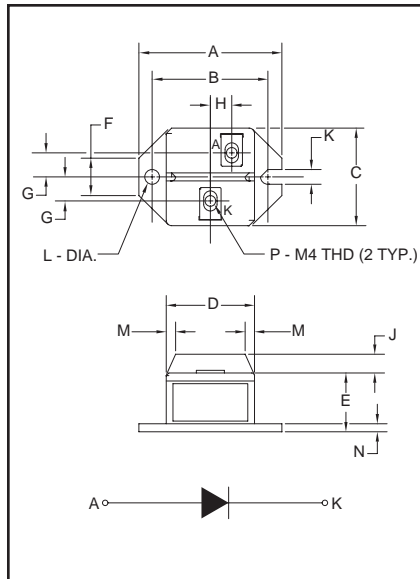

Outline Drawing

Dimension	Inches	Millimeters
A	2.087	53
B	1.705±0.008	43.3±0.2
C	1.417	36
D	1.299	33
E	0.866	22
F	0.551	14
G	0.354	9
H	0.315	8
J	0.276	7
K	0.217	5.5
L	0.217 Dia.	Dia. 5.5
M	0.138	3.5
N	0.118	3
P	M4 Metric	M4



CS240650, CS241250
Fast Recovery
Single Diode Modules
50 Amperes/600-1200 Volts

Description:

Powerex Fast Recovery Single Diode Modules are designed for use in applications requiring fast switching. The modules are isolated for easy mounting with other components on common heatsinks. POW-R-BLOK™ has been tested and recognized by Underwriters Laboratories (QQQX2 Power Switching Semiconductors).

Features:

- Isolated Mounting
- Planar Chips
- UL Recognized

Applications:

- Inverters
- Choppers
- Switching Power Supplies
- Free Wheeling

Ordering Information:

Select the complete eight digit module part number you desire from the table below. Example: CS241250 is a 1200 Volt, 50 Ampere Fast Recovery Single Diode Module.

Type	Voltage Volts (x100)	Current Rating Amperes (50)
CS24	06 12	50



Powerex, Inc., 200 Hillis Street, Youngwood, Pennsylvania 15697-1800 (724) 925-7272

CS240650, CS241250
Fast Recovery Single Diode Modules
50 Amperes/600-1200 Volts

Absolute Maximum Ratings

Characteristics	Symbol	CS240650	CS241250	Units
Peak Reverse Blocking Voltage	V_{RRM}	600	1200	Volts
Transient Peak Reverse Blocking Voltage (Non-Repetitive), $t < 5ms$	V_{RSM}	720	1350	Volts
DC Reverse Blocking Voltage	$V_{R(DC)}$	480	960	Volts
DC Current, $T_C = 105^\circ C$	$I_{F(DC)}$	50	50	Amperes
Peak One-Cycle Surge (Non-Repetitive) On-State Current (60Hz)	I_{FSM}	1000	1000	Amperes
Peak One-Cycle Surge (Non-Repetitive) On-State Current (50Hz)	I_{FSM}	910	910	Amperes
I^2t (for Fusing), 8.3 milliseconds	I^2t	4165	4165	A ² sec
Storage Temperature	T_{STG}	-40 to 125	-40 to 125	°C
Operating Temperature	T_j	-40 to 150	-40 to 150	°C
Maximum Mounting Torque M5 Mounting Screw	—	17	17	in.-lb.
Maximum Mounting Torque M4 Terminal Screw	—	12	12	in.-lb.
Module Weight (Typical)	—	90	90	Grams
V Isolation	V_{RMS}	2500	2500	Volts



Powerex, Inc., 200 Hillis Street, Youngwood, Pennsylvania 15697-1800 (724) 925-7272

CS240650, CS241250
Fast Recovery Single Diode Modules
50 Amperes/600-1200 Volts

Electrical and Thermal Characteristics, $T_j = 25^\circ\text{C}$ unless otherwise specified

Characteristics	Symbol	Test Conditions	CS240650/CS241250	Units
Blocking State Maximums				
Reverse Leakage Current, Peak	I_{RRM}	$T_j = 150^\circ\text{C}$, $V_{RRM} = \text{Rated}$	10	mA
Conducting State Maximums				
Peak On-State Voltage	V_{FM}	$I_{FM} = 50\text{A}$	1.5	Volts
Switching Minimums				
Reverse Recovery Time	t_{rr}	$I_{FM} = 50\text{A}$, $T_j = 150^\circ\text{C}$ $di/dt = -200\text{A}/\mu\text{s}$, $V_R = 1/2 V_{RRM}$	0.8	μs
Reverse Recovery Charge	Q_{rr}	$I_{FM} = 50\text{A}$, $T_j = 150^\circ\text{C}$ $di/dt = -200\text{A}/\mu\text{s}$, $V_R = 1/2 V_{RRM}$	30	μC
Thermal Maximums				
Thermal Resistance, Junction-to-Case	$R_{\theta(J-C)}$	Per Module	0.6	$^\circ\text{C}/\text{Watt}$
Thermal Resistance, Case-to-Sink (Lubricated)	$R_{\theta(C-S)}$	Per Module	0.4	$^\circ\text{C}/\text{Watt}$

CS240650, CS241250
Fast Recovery Single Diode Modules
 50 Amperes/600-1200 Volts

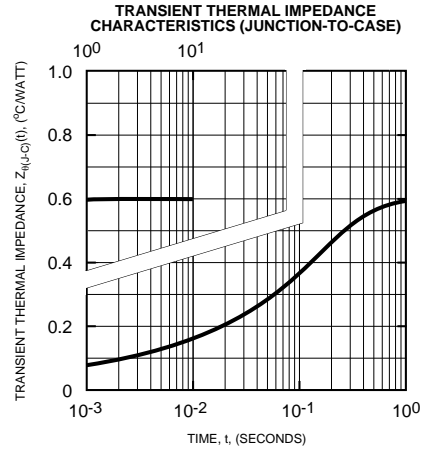
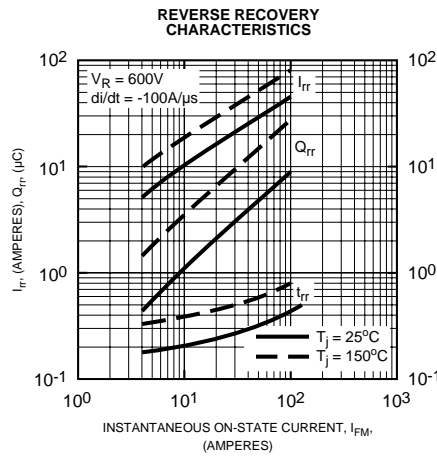
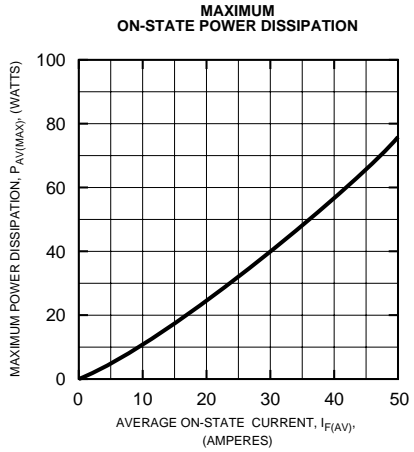
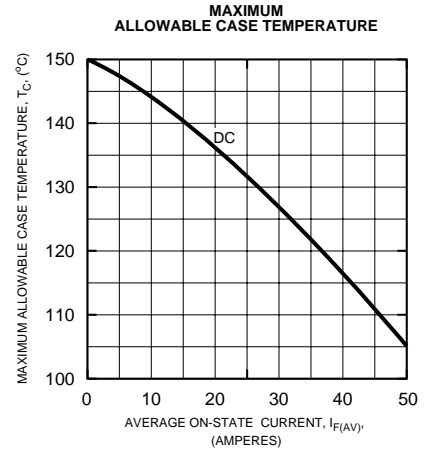
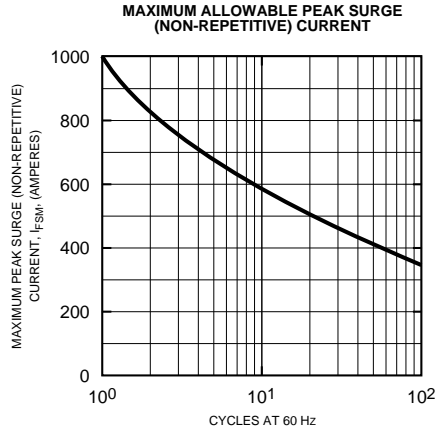
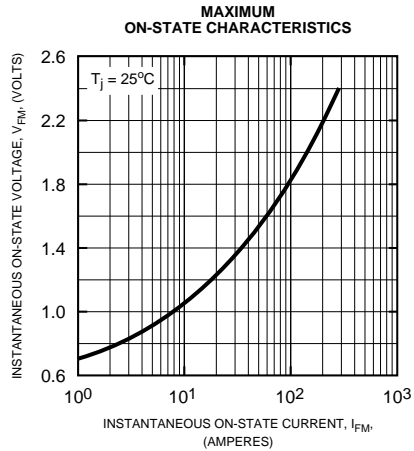



LittleDiode supplies new, hard to find or obsolete electronic components and semiconductors all over the world.

With over two million different components listed you are sure to find the part you need.

Feel free to visit us today at our online store:

LittleDiode.com

Looking forward to providing you with the best possible service.