



**DC COMPONENTS CO., LTD.**

RECTIFIER SPECIALISTS

**HSM101  
THRU  
HSM106**

**TECHNICAL SPECIFICATIONS OF SURFACE MOUNT HIGH EFFICIENCY RECTIFIER**

**VOLTAGE RANGE - 50 to 600 Volts**

**CURRENT - 1.0 Ampere**

**FEATURES**

- \* Ideal for surface mounted applications
- \* Low leakage current
- \* Fast switching for high efficiency
- \* Glass passivated junction

**MECHANICAL DATA**

- \* Case: Molded plastic
- \* Epoxy: UL 94V-0 rate flame retardant
- \* Terminals: Solder plated solderable per MIL-STD-202E, Method 208 guaranteed
- \* Polarity: Color band denotes cathode end
- \* Mounting position: Any
- \* Weight: 0.12 gram

**MAXIMUM RATINGS AND ELECTRICAL CHARACTERISTICS**

Ratings at 25 °C ambient temperature unless otherwise specified.  
Single phase, half wave, 60 Hz, resistive or inductive load.  
For capacitive load, derate current by 20%.



**SM-1(DO-213AB)**

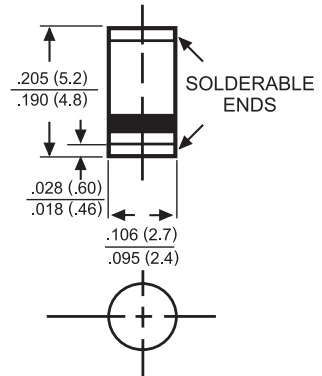

Dimensions in inches and (millimeters)

	SYMBOL	HSM101	HSM102	HSM103	HSM104	HSM105	HSM106	UNITS
Maximum Recurrent Peak Reverse Voltage	V <sub>RRM</sub>	50	100	200	300	400	600	Volts
Maximum RMS Volts	V <sub>RMS</sub>	35	70	140	210	280	420	Volts
Maximum DC Blocking Voltage	V <sub>DC</sub>	50	100	200	300	400	600	Volts
Maximum Average Forward Current at T <sub>A</sub> = 50°C	I <sub>O</sub>	1.0						Amps
Peak Forward Surge Current 8.3 ms single half sine-wave superimposed on rated load (JEDEC Method)	I <sub>FSM</sub>	30						Amps
Maximum Instantaneous Forward Voltage at 1.0A DC	V <sub>F</sub>	1.0		1.3		1.7		Volts
Maximum DC Reverse Current at Rated DC Blocking Voltage	I <sub>R</sub>	5.0						uAmps
		100						
Maximum Reverse Recovery Time (Note 1)	t <sub>rr</sub>	50				75		nSec
Typical Junction Capacitance (Note 2)	C <sub>J</sub>	15						pF
Operating and Storage Temperature Range	T <sub>J</sub> , T <sub>STG</sub>	-65 to + 175						°C

NOTES : 1. Test Conditions: I<sub>F</sub>=0.5A, I<sub>R</sub>=1.0A, I<sub>RR</sub>=0.25A.  
2. Measured at 1 MHz and applied reverse voltage of 4.0 volts.

# RATING AND CHARACTERISTIC CURVES ( HSM101 THRU HSM106 )

FIG. 1 - TEST CIRCUIT DIAGRAM AND REVERSE RECOVERY TIME CHARACTERISTIC

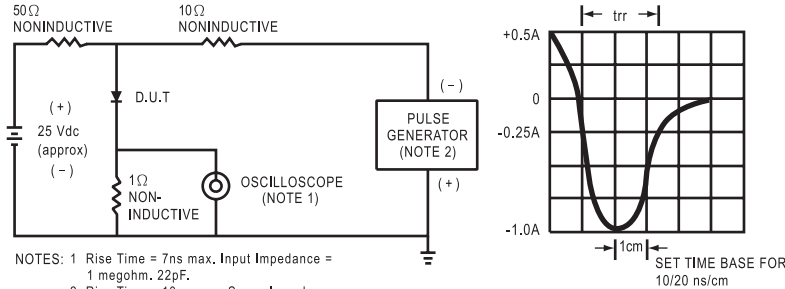

FIG. 2 - TYPICAL FORWARD CURRENT DERATING CURVE

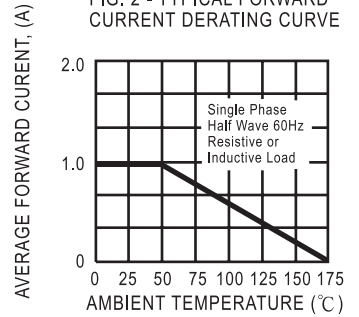

FIG. 3 - TYPICAL REVERSE CHARACTERISTICS

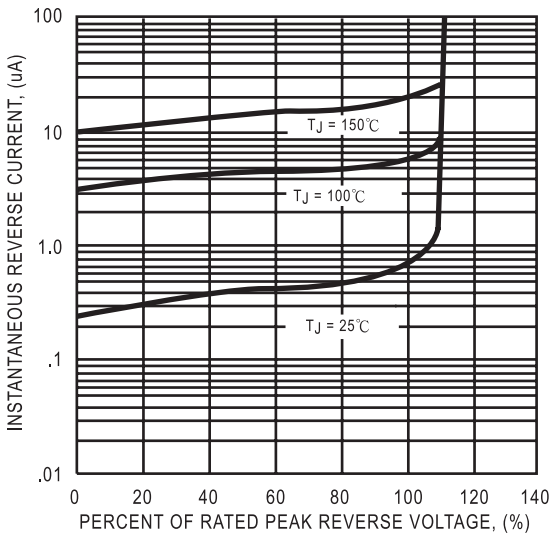

FIG. 4 - TYPICAL INSTANTANEOUS FORWARD CHARACTERISTICS

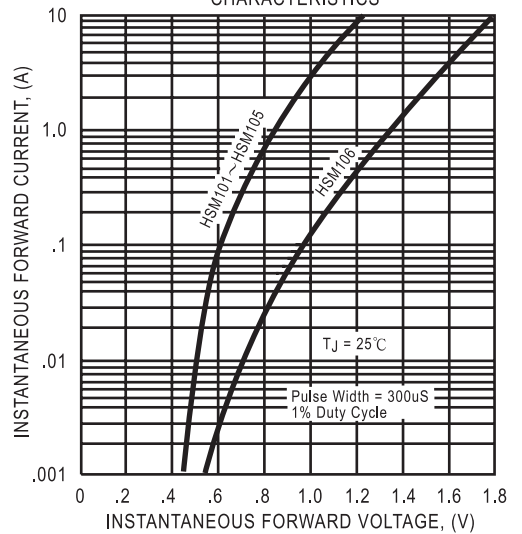

FIG. 5 - MAXIMUM NON-REPETITIVE FORWARD SURGE CURRENT

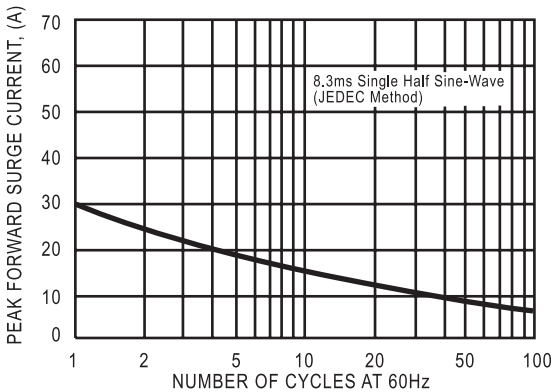
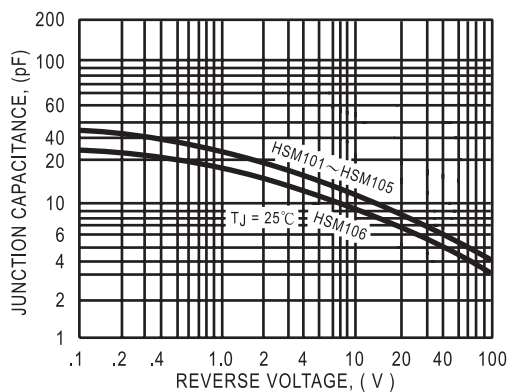

FIG. 6 - TYPICAL JUNCTION CAPACITANCE



DC COMPONENTS CO., LTD.



LittleDiode supplies new, hard to find or obsolete electronic components and semiconductors all over the world.

With over two million different components listed you are sure to find the part you need.

Feel free to visit us today at our online store:

**[LittleDiode.com](http://LittleDiode.com)**

Looking forward to providing you with the best possible service.