

HER801 THRU HER806

8.0 AMP HIGH EFFICIENCY RECTIFIERS

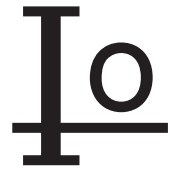

FEATURES

- * Low forward voltage drop
- * High current capability
- * High reliability
- * High surge current capability
- * High speed switching

MECHANICAL DATA

- * Case: Molded plastic
- * Epoxy: UL 94V-0 rate flame retardant
- * Lead: Lead solderable per MIL-STD-202, method 208 guaranteed
- * Polarity: As Marked
- * Mounting position: Any
- * Weight: 2.24 grams

VOLTAGE RANGE

50 to 600 Volts

CURRENT

8.0 Ampere

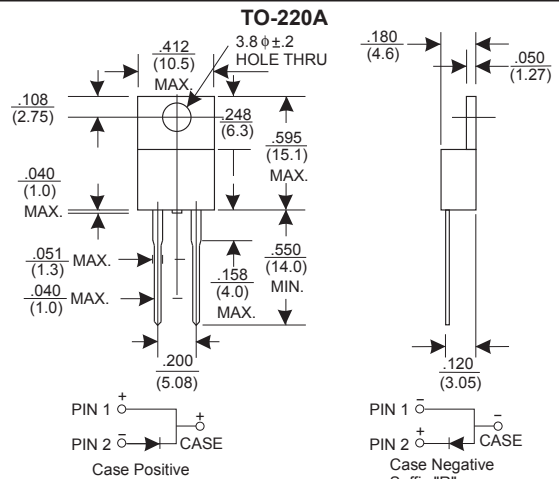

Dimensions in inches and (millimeters)

MAXIMUM RATINGS AND ELECTRICAL CHARACTERISTICS

Rating 25°C ambient temperature unless otherwise specified.
Single phase half wave, 60Hz, resistive or inductive load.
For capacitive load, derate current by 20%.

TYPE NUMBER	HER801	HER802	HER803	HER804	HER805	HER806	UNITS
Maximum Recurrent Peak Reverse Voltage	50	100	200	300	400	600	V
Maximum RMS Voltage	35	70	140	210	280	420	V
Maximum DC Blocking Voltage	50	100	200	300	400	600	V
Maximum Average Forward Rectified Current .375"(9.5mm) Lead Length at Tc=75°C	8.0						A
Peak Forward Surge Current, 8.3 ms single half sine-wave superimposed on rated load (JEDEC method)	150						A
Maximum Instantaneous Forward Voltage at 8.0A	1.0		1.3		1.85		V
Maximum DC Reverse Current Tc=25°C	10.0						µA
at Rated DC Blocking Voltage Tc=100°C	200						µA
Maximum Reverse Recovery Time (Note 1)	60					100	nS
Typical Junction Capacitance (Note 2)	65						pF
Operating and Storage Temperature Range Tj, Tstg	-55 — +150						°C

NOTES:

- Reverse Recovery Time test condition: IF=0.5A, IR=1.0A, IRR=0.25A
- Measured at 1MHz and applied reverse voltage of 4.0V D.C.

RATING AND CHARACTERISTIC CURVES (HER801 THRU HER807)

FIG. 1-TYPICAL FORWARD CHARACTERISTICS

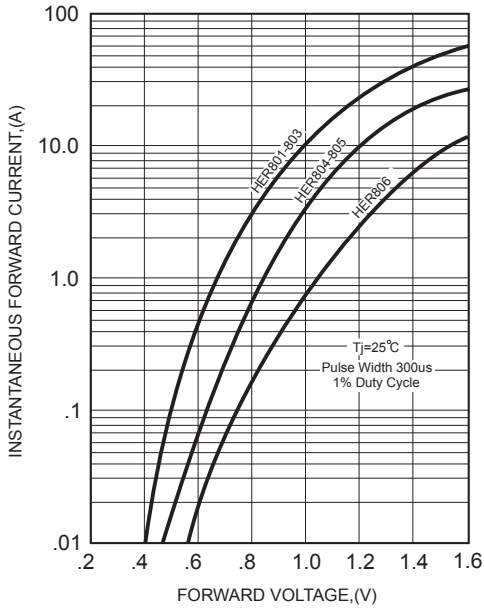

FIG. 2-TYPICAL FORWARD CURRENT DERATING CURVE

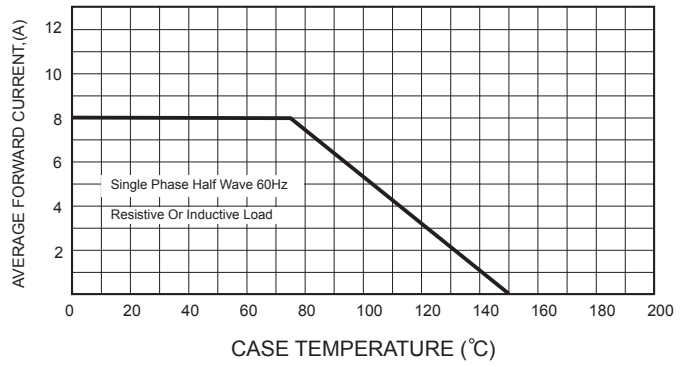

FIG. 4-MAXIMUM NON-REPETITIVE FORWARD SURGE CURRENT

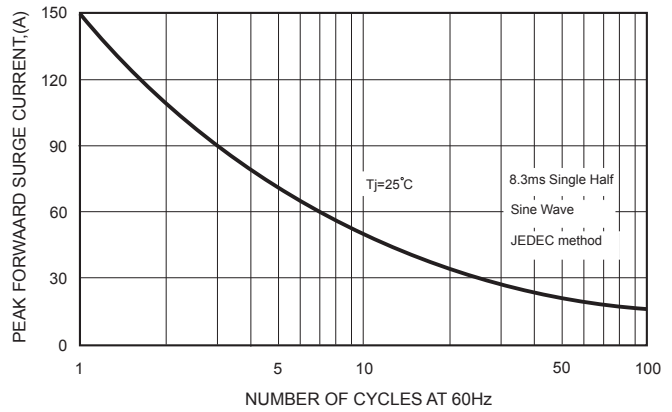
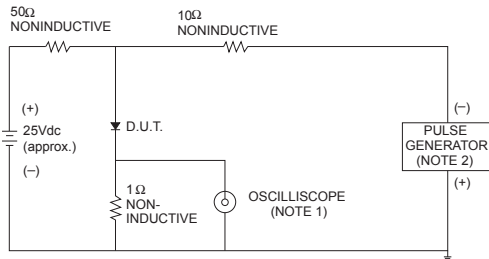

FIG. 3- TEST CIRCUIT DIAGRAM AND REVERSE RECOVERY TIME CHARACTERISTICS



- NOTES: 1. Rise Time= 7ns max., Input Impedance= 1 megohm, 22pF.
 2. Rise Time= 10ns max., Source Impedance= 50 ohms.

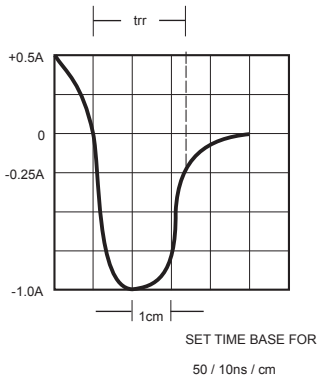
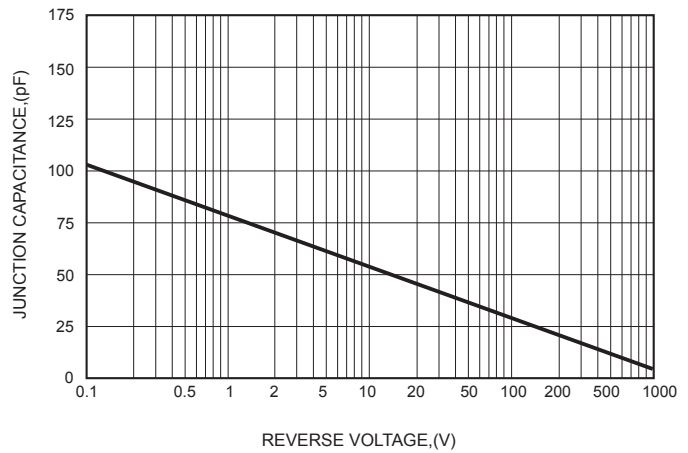

FIG. 5-TYPICAL JUNCTION CAPACITANCE





LittleDiode supplies new, hard to find or obsolete electronic components and semiconductors all over the world.

With over two million different components listed you are sure to find the part you need.

Feel free to visit us today at our online store:

LittleDiode.com

Looking forward to providing you with the best possible service.