

STANDARD RECOVERY DIODES

Stud Version

Features

- High surge current capability
- Avalanche types available
- Stud cathode and stud anode version
- Wide current range
- Types up to 1200V V_{RRM}

25 A

Typical Applications

- Battery charges
- Converters
- Power supplies
- Machine tool controls

Major Ratings and Characteristics

Parameters	25F(R)	Units
$I_{F(AV)}$	25	A
@ T_C	120	°C
$I_{F(RMS)}$	40	A
I_{FSM} @ 50Hz	356	A
@ 60Hz	373	A
I^2t @ 50Hz	636	A ² s
@ 60Hz	580	A ² s
V_{RRM} range	100 to 1200	V
T_J range	- 65 to 175	°C

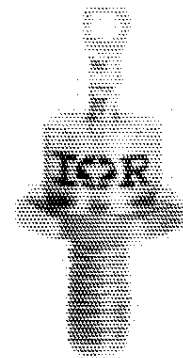

case style
DO-203AA (DO-4)

ELECTRICAL SPECIFICATIONS

Voltage Ratings

Type number	Voltage Code	V_{RRM} , maximum repetitive peak reverse voltage V	V_{RSM} , maximum non-repetitive peak reverse voltage V	$V_{R(BR)}$, minimum avalanche voltage V (1)	I_{RRM} max. @ $T_J = 175^\circ\text{C}$ mA
25F(R)	10	100	150	--	12
	20	200	275	--	
	40	400	500	500	
	60	600	725	750	
	80	800	950	950	
	100	1000	1200	1150	
	120	1200	1400	1350	

(1) Avalanche version only available from V_{RRM} 400V to 1200V.

Forward Conduction

Parameter	25F(R)	Units	Conditions
$I_{F(AV)}$ Max. average forward current @ Case temperature	25	A	180° conduction, half sine wave
	120	°C	
$I_{F(RMS)}$ Max. RMS forward current	40	A	DC @ $T_C = 25^\circ\text{C}$
P_R Maximum non-repetitive peak reverse power	10	K/W	10µs square pulse, $T_J = T_J$ max. see note (2)
I_{FSM} Max. peak, one-cycle forward, non-repetitive surge current	356	A	t = 10ms No voltage reappplied
	373		t = 8.3ms
	300		t = 10ms 100% V_{RRM} reappplied
	314		t = 8.3ms
I^2t Maximum I^2t for fusing	636	A ² s	t = 10ms No voltage reappplied
	580		t = 8.3ms
	450		t = 10ms 100% V_{RRM} reappplied
	410		t = 8.3ms
$I^2\sqrt{t}$ Maximum $I^2\sqrt{t}$ for fusing	6360	A ² √s	t = 0.1 to 10ms, no voltage reappplied
$V_{F(TO)1}$ Low level value of threshold voltage	0.80	V	$(16.7\% \times \pi \times I_{F(AV)} < I < \pi \times I_{F(AV)})$, $T_J = T_J$ max.
$V_{F(TO)2}$ High level value of threshold voltage	0.90		$(I > \pi \times I_{F(AV)})$, $T_J = T_J$ max.
r_{f1} Low level value of forward slope resistance	6.80	mΩ	$(16.7\% \times \pi \times I_{F(AV)} < I < \pi \times I_{F(AV)})$, $T_J = T_J$ max.
r_{f2} High level value of forward slope resistance	5.70		$(I > \pi \times I_{F(AV)})$, $T_J = T_J$ max.
V_{FM} Max. forward voltage drop	1.30	V	$I_{pk} = 78\text{A}$, $T_J = 25^\circ\text{C}$, $t_p = 10\text{ms}$ sinusoidal wave

(2) Available only for Avalanche version, all other parameters the same as 25F.

Thermal and Mechanical Specifications

Parameter	25F(R)	Units	Conditions
T_J Max. junction operating temperature range	-65 to 175	°C	
T_{stg} Max. storage temperature range	-65 to 200		
R_{thJC} Max. thermal resistance, junction to case	1.5	K/W	DC operation
R_{thCS} Max. thermal resistance, case to heatsink	0.5		Mounting surface, smooth, flat and greased
T Mounting torque, $\pm 10\%$	1.2 (1.5)	Nm	Lubricated threads (Not lubricated threads)
wt Approximate weight	7 (0.25)	g (oz)	
Case style	DO-203AA (DO-4)		See Outline Table

 ΔR_{thJC} Conduction

(The following table shows the increment of thermal resistance R_{thJC} when devices operate at different conduction angles than DC)

Conduction angle	Sinusoidal conduction	Rectangular conduction	Units	Conditions
180°	0.28	0.24	K/W	$T_J = T_{J \text{ max.}}$
120°	0.39	0.41		
90°	0.50	0.54		
60°	0.73	0.75		
30°	1.20	1.21		

Ordering Information Table

Device Code	
1	- A = Avalanche diode None = Standard diode
2	- Current rating: Code = $I_{F(AV)}$
3	- F = Standard device
4	- None = Stud Normal Polarity (Cathode to Stud) R = Stud Reverse Polarity (Anode to Stud)
5	- Voltage code: Code x 10 = V_{RRM} (See Voltage Ratings table)
6	- None = Stud base DO-203AA (DO-4) 10-32UNF-2A M = Stud base DO-203AA (DO-4) M5 X 0.8 - (Not available for Avalanche diodes)

Outlines Table

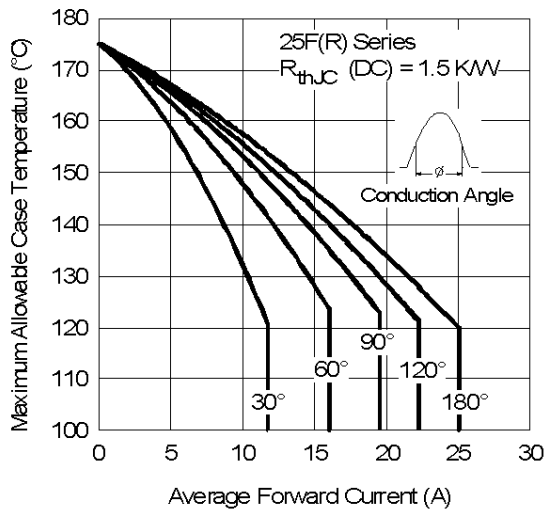
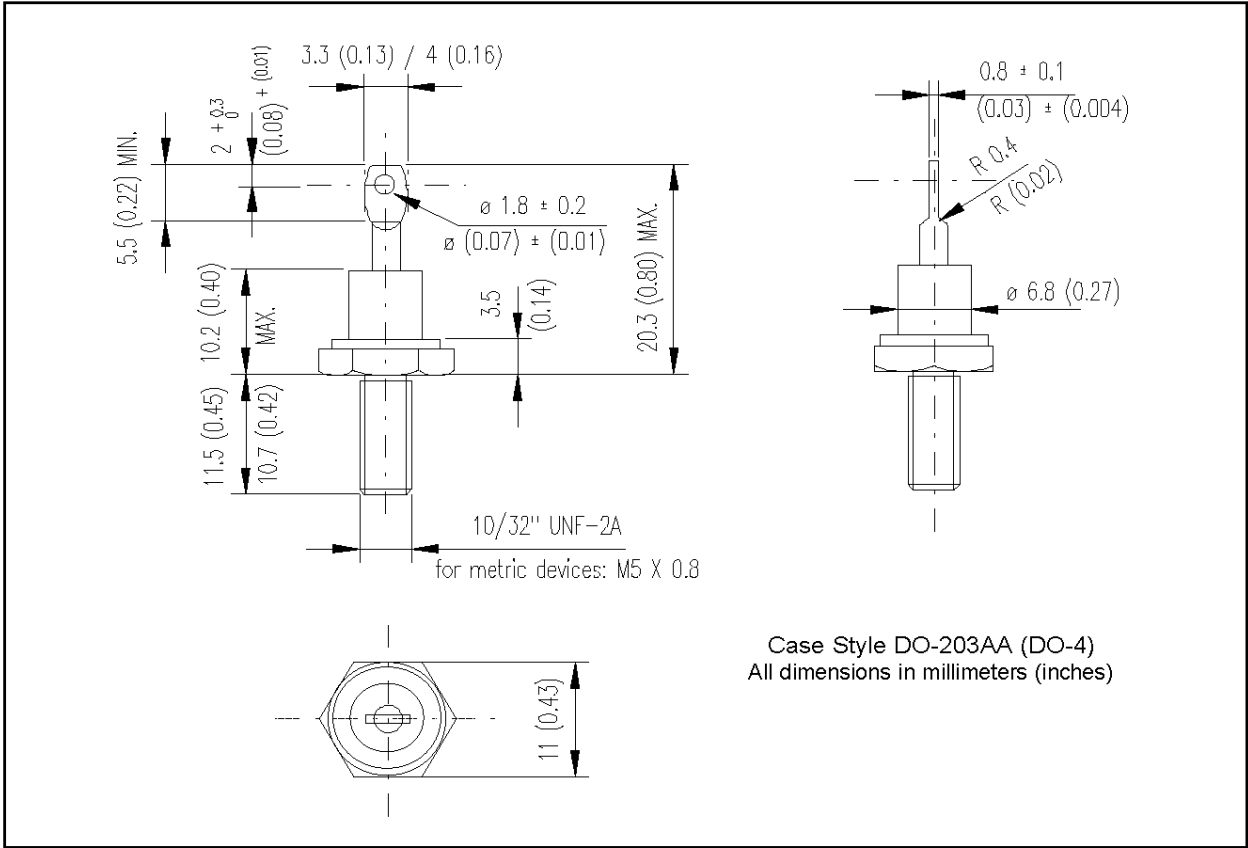

Fig. 1 - Current Ratings Characteristics

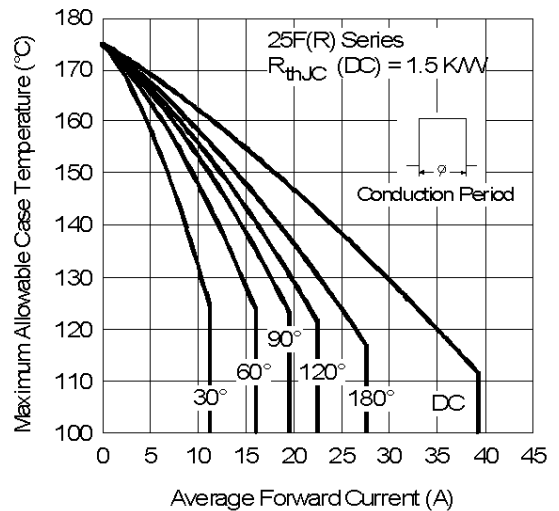

Fig. 2 - Current Ratings Characteristics

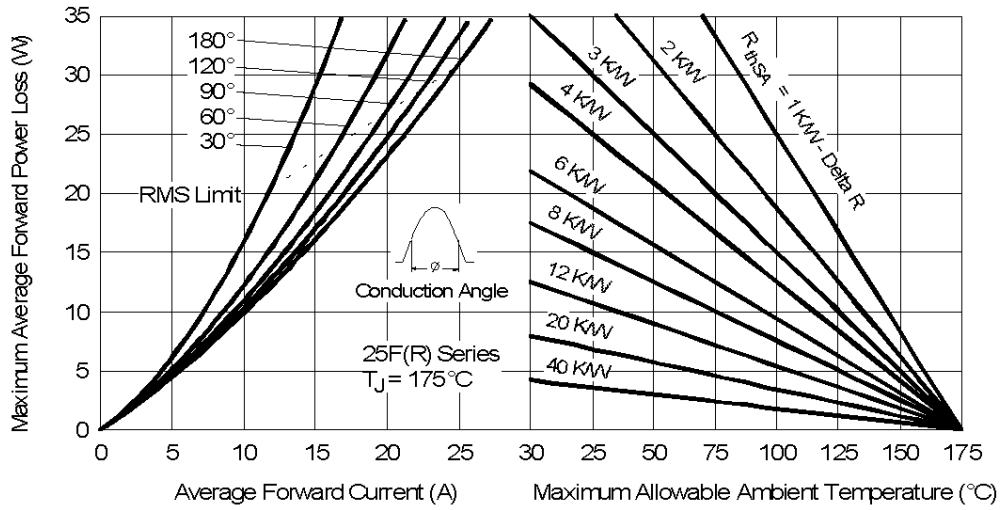

Fig. 3 - Forward Power Loss Characteristics

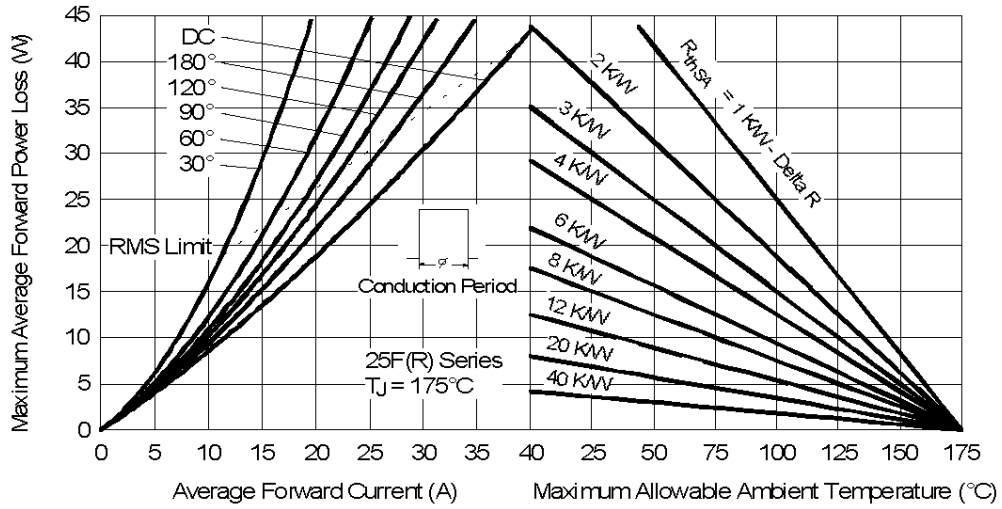

Fig. 4 - Forward Power Loss Characteristics

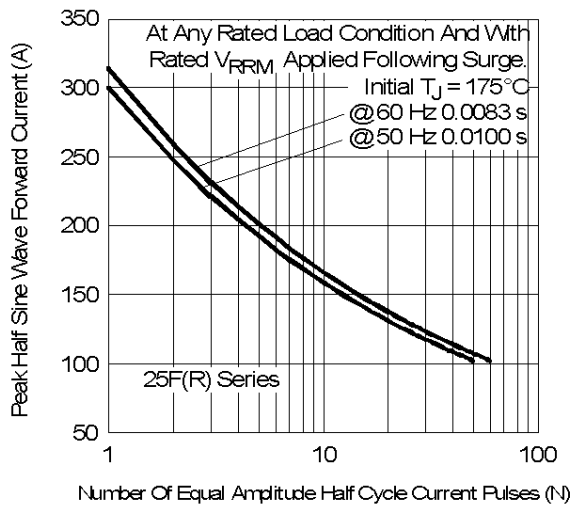

Fig. 5 - Maximum Non-Repetitive Surge Current

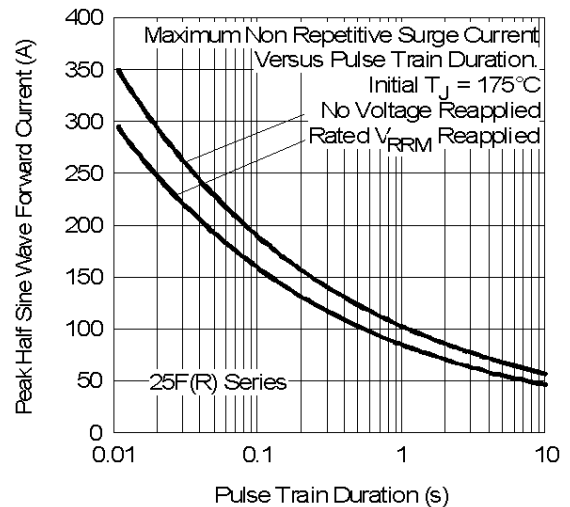

Fig. 6 - Maximum Non-Repetitive Surge Current

25F(R) Series

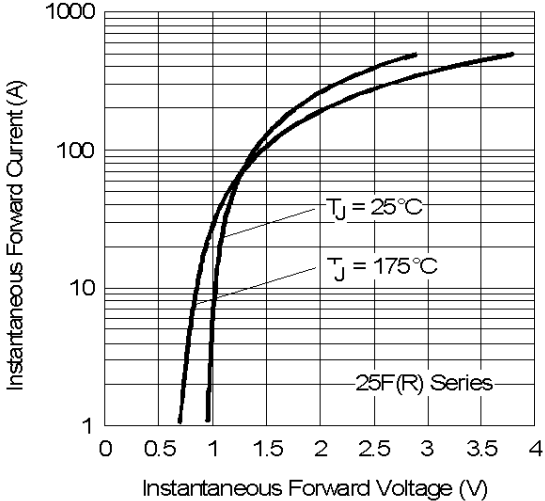

Fig. 7 - Forward Voltage Drop Characteristics

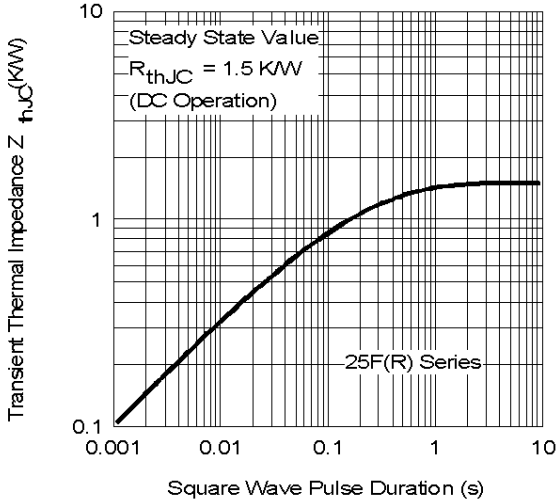

Fig. 8 - Thermal Impedance Z_{thJC} Characteristics



LittleDiode supplies new, hard to find or obsolete electronic components and semiconductors all over the world.

With over two million different components listed you are sure to find the part you need.

Feel free to visit us today at our online store:

LittleDiode.com

Looking forward to providing you with the best possible service.