



GOOD-ARK

40HF(R) SERIES

POWER RECTIFIER

Reverse Voltage - 100 to 1600 Volts

Forward Current - 40.0 Amperes

Features

- High surge current capability
- Designed for a wide range of applications
- Stud cathode and stud anode version
- Leaded version available
- Types up to 1600V V_{RRM}

Typical Applications

- Battery charges
- Converters
- Power supplies
- Machine tool controls



case style
DO-203AB (DO-5)

Mechanical Data

- **Case:** DO-203AB(DO-5)
- **Polarity:** Selection available
- **Weight:** 17 grams

Major Ratings and Characteristics

Parameters		40HF(R)		Units
		10 to 120	140 to 160	
$I_{F(AV)}$		40	40	Amps
	@ T_C	140	110	$^{\circ}C$
$I_{F(RMS)}$		62		Amps
I_{FSM}	@50Hz	570		Amps
	@60Hz	595		Amps
I^2t	@50Hz	1600		A^2s
	@60Hz	1450		A^2s
V_{RRM}	range	100 to 1200	1400 to 1600	Volts
T_J	range	-65 to 190	-65 to 160	$^{\circ}C$

ELECTRICAL SPECIFICATIONS

Voltage Ratings

Type number	Voltage Code	V_{RRM} maximum repetitive peak reverse voltage Volts	V_{RSM} maximum non-repetitive peak reverse voltage Volts	$V_{R(BR)}$ minimum avalanche voltage Volts ⁽¹⁾	I_{RRM} max. @ $T_J=T_J$ max. mA
40HF(R)	10	100	200	-	15
	20	200	300	-	
	40	400	500	500	
	60	600	720	725	9
	80	800	960	950	
	100	1000	1200	1150	
	120	1200	1440	1350	4.5
	140	1400	1650	1550	
	160	1600	1900	1750	

(1) Avalanche version only available from V_{RRM} 400V to 1600V.

Forward Conduction

Parameter		40HF(R)		Units	Conditions		
		10 to 120	140 to 160				
$I_{F(AV)}$	Max. average forward current @ Case temperature	40	40	Amps	180° conduction, half sine wave		
		140	110	°C			
$I_{F(RMS)}$	Max. RMS forward current	62		Amps			
I_{FSM}	Max. peak, one-cycle forward, non-repetitive surge current	570		Amps	t=10ms	No voltage reapplied	Sinusoidal half wave Initial $T_J=T_J$ max.
		595			t=8.3ms		
		480			t=10ms	100% V_{RRM} reapplied	
		500			t=8.3ms		
I^2t	Maximum I^2t for fusing	1600		A ² S	t=10ms	No voltage reapplied	
		1450			t=8.3s		
		1150			t=10ms	100% V_{RRM} reapplied	
		1050			t=8.3ms		
V_{FM}	Max. forward voltage drop	1.30		Volts	$I_{pk}=125A, T_J=25°C, t_p=400\mu s$ rectangular wave		

Thermal and Mechanical Specifications

Parameter	40HF(R)		Units	Conditions
	10 to 120	140 to 160		
T_J Max. junction operating temperature range	-65 to 190	-65 to 160	°C	
T_{slg} Max. storage temperature range	-65 to 190	-65 to 160		
R_{thJC} Max. thermal resistance, junction to case	1.0		K/W	DC operation
R_{thCS} Max. thermal resistance, case to heatsink	0.25			Mounting surface, smooth, flat and greased
T Max. allowed mounting torque 10%	2.3-2.4		Nm	Not lubricated threads
	20-30		lbf-in	
wt approximate weight	17 (0.6)		g(oz)	
Case style	DO-203AB (DO-5)		See Outline Table	

Ordering information Table

Device Code: 40 HF R 160 M
 1 2 3 4 5

1. 40 - Standard device
2. HF - Standard diode
3. None - stud normal polarity (cathode to stud)
 R - stud reverse polarity (Anode to stud)
4. Voltage code: cade x 10= V_{RRM}
5. None - stud base DO-203AB (DO-5) 1/4" 28 UNF-2A
 M - stud base DO-203AB (DO-5) M6x1

Outlines Table

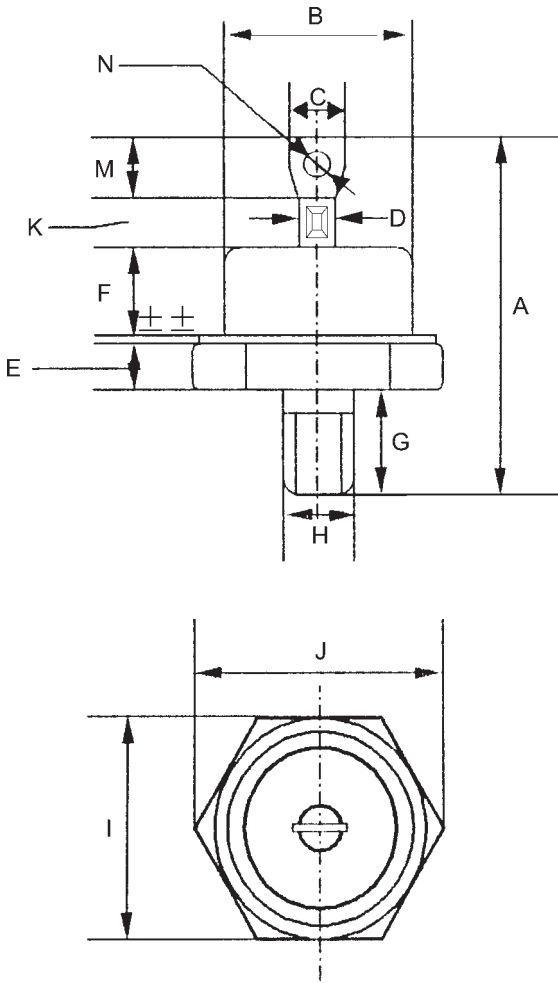

40HF(R)

Case Style DO-203AB(DO-5)

All dimenions in millimeters(inches)

DIMENSIONS			
DIM	inches	mm	Note
A		34.06	
B		12.83	
C		6.48	
D		3.68	
E		3.30	
F		5.92	
G		11.10	
H		5.84	
I		17.27	
J		19.05	
K		5.38	
M		7.42	
N		φ 3.8	

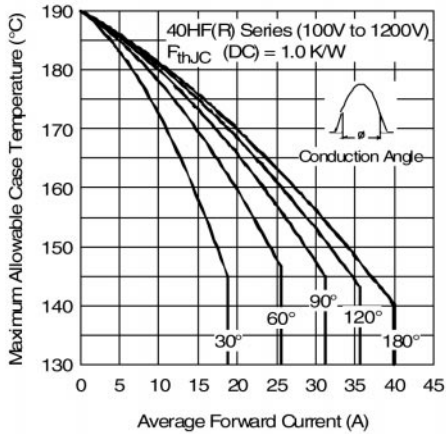

Fig. 1 - Current Ratings Characteristics

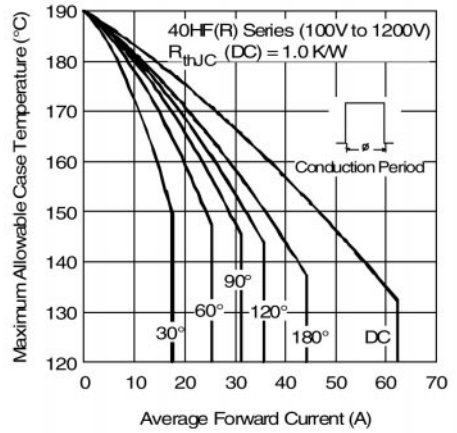

Fig. 2 - Current Ratings Characteristics

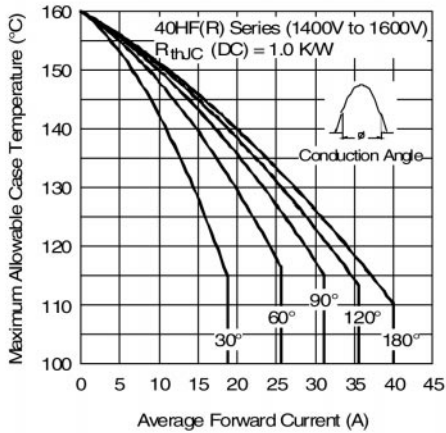

Fig. 3 - Current Ratings Characteristics

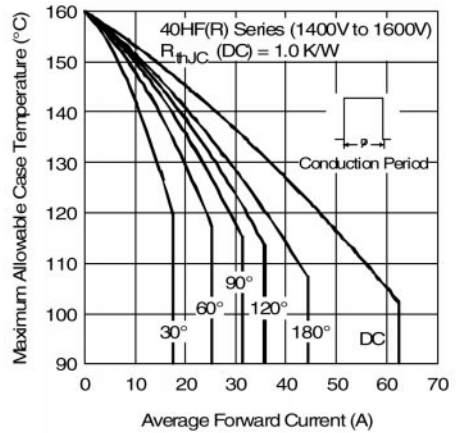

Fig. 4 - Current Ratings Characteristics

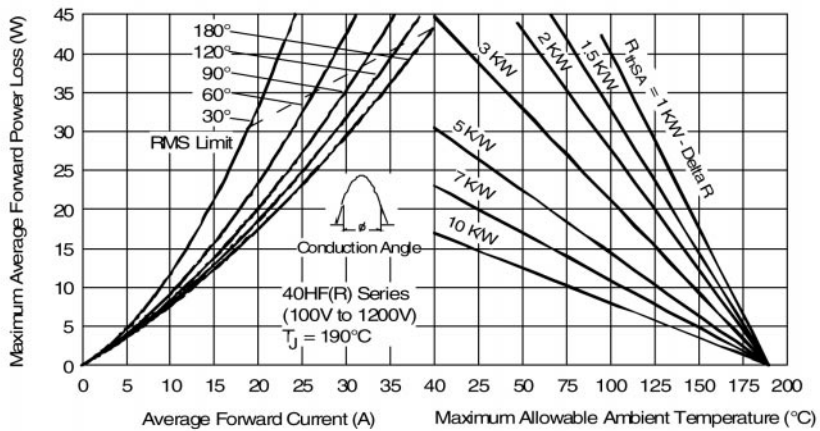

Fig. 5 - Forward Power Loss Characteristics

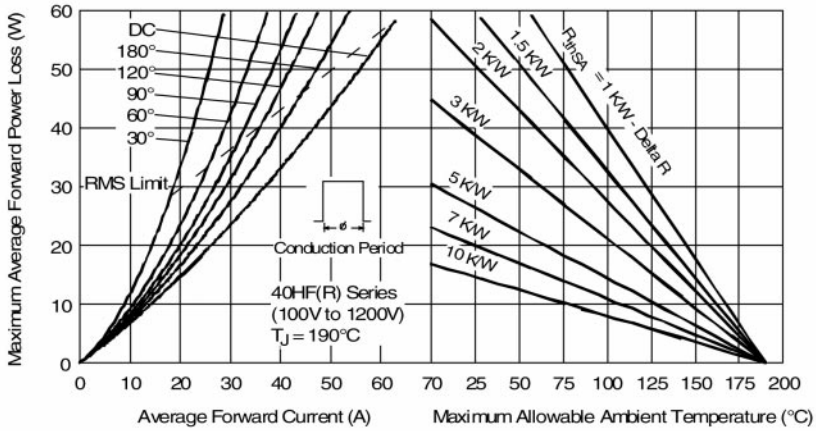

Fig. 6 - Forward Power Loss Characteristics

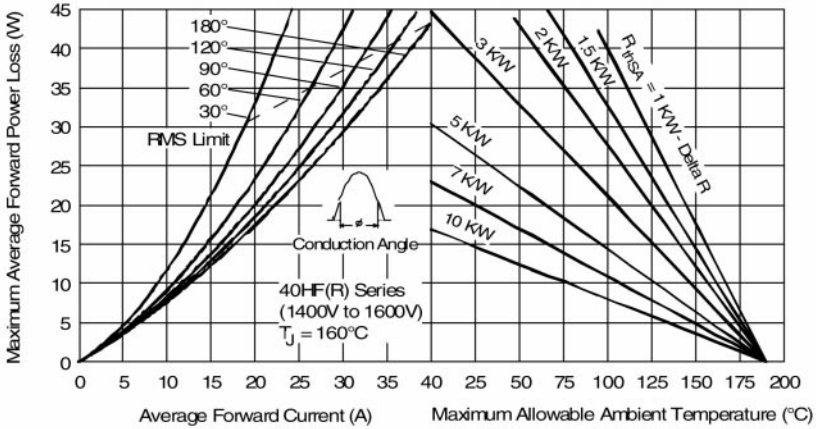

Fig. 7 - Forward Power Loss Characteristics

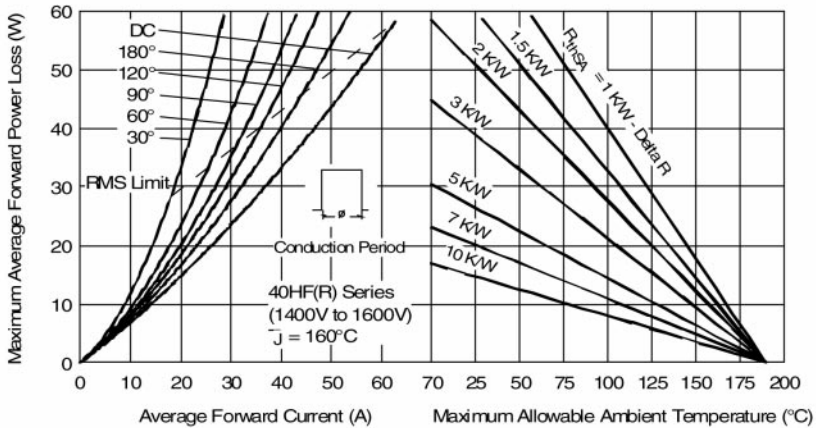

Fig. 8 - Forward Power Loss Characteristics

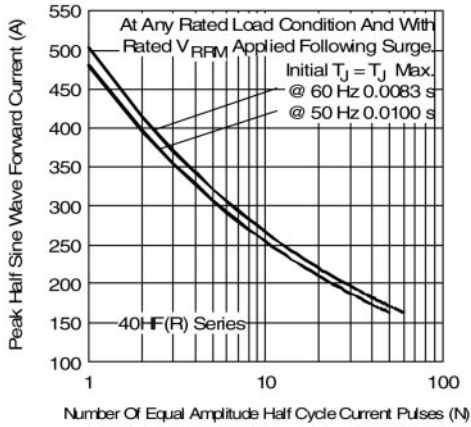

Fig. 9 - Maximum Non-Repetitive Surge Current

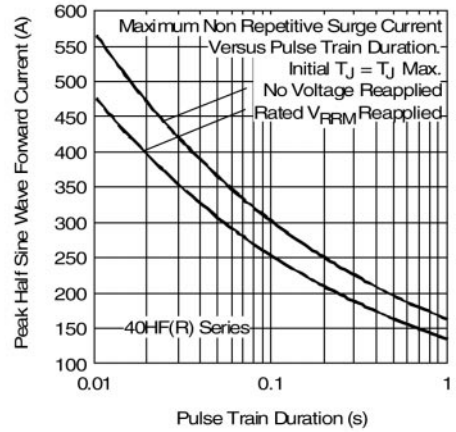

Fig. 10 - Maximum Non-Repetitive Surge Current

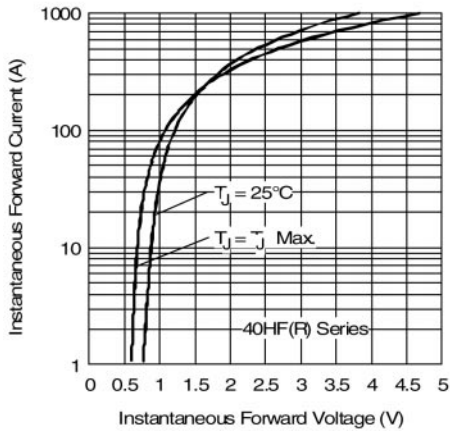

Fig. 11 - Forward Voltage Drop Characteristics

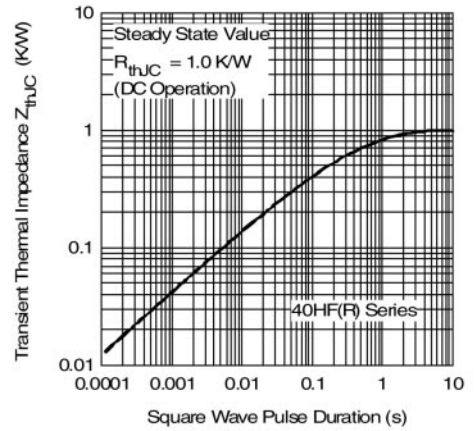

Fig. 12 - Thermal Impedance Z_{thJC} Characteristics



LittleDiode supplies new, hard to find or obsolete electronic components and semiconductors all over the world.

With over two million different components listed you are sure to find the part you need.

Feel free to visit us today at our online store:

LittleDiode.com

Looking forward to providing you with the best possible service.