

STANDARD DIODES

ADD-A-pak™ GEN V Power Modules

Features

- High Voltage
- Industrial Standard Package
- Thick Al metal die and double stick bonding
- Thick copper baseplate
- UL E78996 approved
- 3500V_{RMS} isolating voltage

Benefits

- Up to 1600V
- Full compatible TO-240AA
- High Surge capability
- Easy Mounting on heatsink
- Al₂O₃ DBC insulator
- Heatsink grounded

60 A
80 A

Mechanical Description

The Generation V of Add-A-pak module combine the excellent thermal performance obtained by the usage of Direct Bonded Copper substrate with superior mechanical ruggedness, thanks to the insertion of a solid Copper baseplate at the bottom side of the device. The Cu baseplate allow an easier mounting on the majority of heatsink with increased tolerance of surface roughness and improve thermal spread.

The Generation V of AAP module is manufactured without hard mold, eliminating in this way any possible direct stress on the leads.

The electrical terminals are secured against axial pull-out: they are fixed to the module housing via a click-stop feature already tested and proved as reliable on other IR modules.

Electrical Description

These modules are intended for general purpose high voltage applications such as high voltage regulated power supplies, lighting circuits, temperature and motor speed control circuits, UPS and battery charger.

Major Ratings and Characteristics

Parameters	IRK.56	IRK.71	Units
$I_{F(AV)}$ @ 100°C	60	80	A
$I_{F(RMS)}$	94	126	A
I_{FSM} @ 50Hz	1600	1790	A
@ 60Hz	1680	1870	A
i^2t @ 50Hz	12.89	15.90	KA ² s
@ 60Hz	11.76	14.53	KA ² s
$i^2\sqrt{t}$	128.9	159	KA ² √s
V_{RRM} range	400 to 1600		V
T_J	-40 to 150		°C
T_{STG}	-40 to 150		°C



IRK.56, .71 Series

Bulletin I27140 rev. E 10/02

International
IR Rectifier

ELECTRICAL SPECIFICATIONS

Voltage Ratings

Type number	Voltage Code	V_{RRM} , maximum repetitive peak reverse voltage V	V_{RSM} , maximum non-repetitive peak rev. voltage V	I_{RRM} max. @ 150°C mA
IRK.56/.71	04	400	500	10
	06	600	700	
	08	800	900	
	10	1000	1100	
	12	1200	1300	
	14	1400	1500	
	16	1600	1700	

Forward Conduction

Parameter	IRK.56	IRK.71	Units	Conditions
$I_{F(AV)}$ Max. average forward current @ Case temperature	60	80	A	180° conduction, half sine wave
	100	100	°C	
$I_{F(AV)}$ Max. average forward current @ Case temperature	55	70	A	180° conduction, half sine wave
	105	108	°C	
$I_{F(RMS)}$ Max. RMS forward current	94	126	A	DC @ 92°C case temperature
I_{FSM} Max. peak, one-cycle forward, non-repetitive surge current	1600	1790	A	t = 10ms No voltage reappplied
	1680	1870		t = 8.3ms 100% V_{RRM} reappplied
	1350	1500		t = 10ms 100% V_{RRM} reappplied
	1420	1570		t = 8.3ms 100% V_{RRM} reappplied
I^2t Maximum I^2t for fusing	12.89	15.90	KA ² s	t = 10ms No voltage reappplied
	11.76	14.53		t = 8.3ms 100% V_{RRM} reappplied
	9.12	11.25		t = 10ms 100% V_{RRM} reappplied
	8.32	10.23		t = 8.3ms 100% V_{RRM} reappplied
I^2/\sqrt{t} Maximum I^2/\sqrt{t} for fusing	128.9	159.0	KA ² /s	t = 0.1 to 10ms, no voltage reappplied
$V_{F(TO)1}$ Low level value of threshold voltage	0.96	0.83	V	$(16.7\% \times \pi \times I_{F(AV)} < I < \pi \times I_{F(AV)})$, $T_J = T_J \text{ max.}$
$V_{F(TO)2}$ High level value of threshold voltage	1.03	0.92		$(I > \pi \times I_{F(AV)})$, $T_J = T_J \text{ max.}$
r_{f1} Low level value of forward slope resistance	2.81	2.68	mΩ	$(16.7\% \times \pi \times I_{F(AV)} < I < \pi \times I_{F(AV)})$, $T_J = T_J \text{ max.}$
r_{f2} High level value of forward slope resistance	2.48	2.40		$(I > \pi \times I_{F(AV)})$, $T_J = T_J \text{ max.}$
V_{FM} Max. forward voltage drop	1.51	1.50	V	$I_{FM} = \pi \times I_{F(AV)}$, $T_J = 25^\circ\text{C}$, $t_p = 400\mu\text{s}$ square wave

Blocking

Parameter	IRK.56	IRK.71	Units	Conditions
I_{RRM} Max. peak reverse leakage current	10		mA	$T_J = 150^\circ\text{C}$
V_{INS} RMS isolation voltage	3500 (1 sec)		V	50 Hz, circuit to base, all terminals shorted

Thermal and Mechanical Specifications

Parameter	IRK.56	IRK.71	Units	Conditions
T _J Junction temperature range	-40 to 150		°C	
T _{stg} Storage temperature range	-40 to 150		°C	
R _{thJC} Max. thermal resistance, junction to case	0.5	0.4	K/W	Per junction, DC operation
R _{thCS} Typical thermal resistance, case to heatsink	0.1		K/W	Mounting surface flat, smooth and greased
T Mounting torque ±10% to heatsink busbar	5 4		Nm	A mounting compound is recommended and the torque should be rechecked after a period of 3 hours to allow for the spread of the compound
wt Approximate weight	110 (4)		gr (oz)	
Case style	TO-240AA			JEDEC

ΔR Conduction (per Junction)

(The following table shows the increment of thermal resistance R_{thJC} when devices operate at different conduction angles than DC)

Devices	Sine half wave conduction					Rect. wave conduction					Units
	180°	120°	90°	60°	30°	180°	120°	90°	60°	30°	
IRK.56	0.11	0.13	0.16	0.22	0.32	0.09	0.14	0.17	0.23	0.32	°C/W
IRK.71	0.06	0.08	0.11	0.14	0.21	0.06	0.09	0.11	0.15	0.21	

Ordering Information Table

Device Code

IRK	D	71	/	16	A
①	②	③		④	⑤

1	-	Module type
2	-	Circuit configuration (See Circuit Configuration Table)
3	-	Current code
4	-	Voltage code (See Voltage Ratings Table)
5	-	A: Gen V

IRK.56, .71 Series

Bulletin I27140 rev. E 10/02

Outline Table

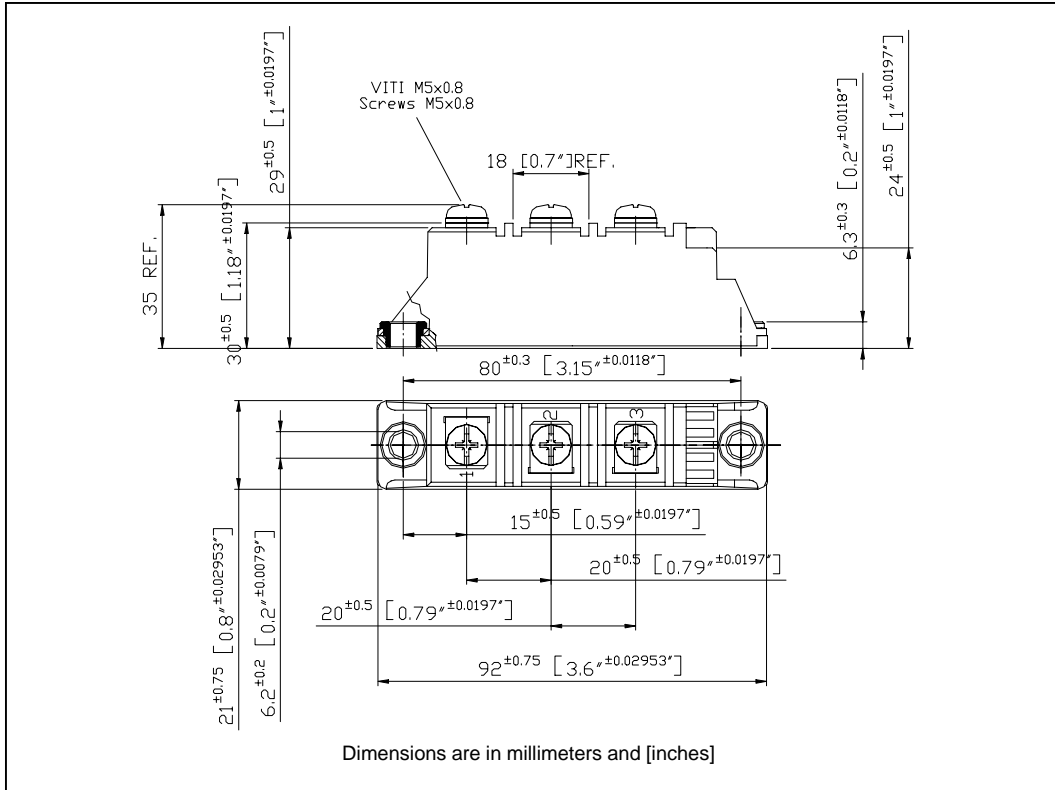

Circuit Configuration Table

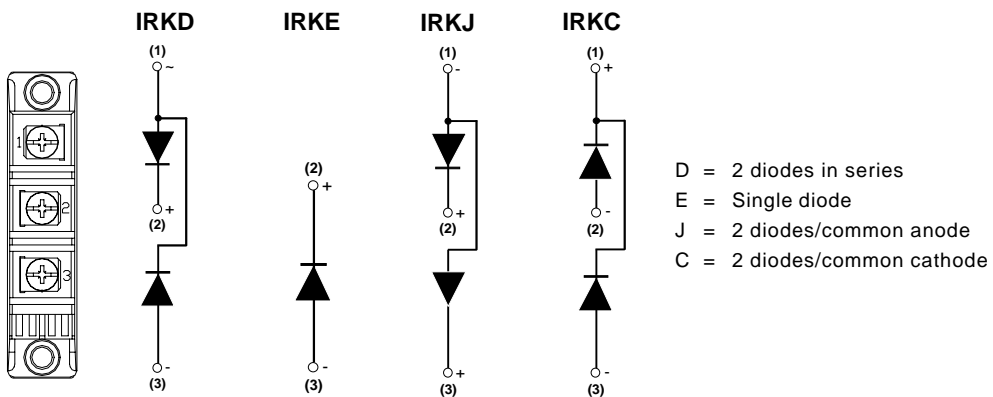

NOTE: To order the Optional Hardware see Bulletin I27900

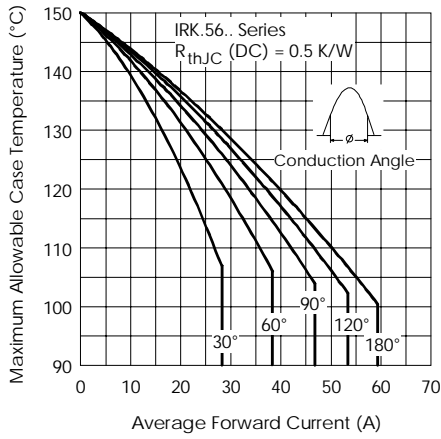

Fig. 1 - Current Ratings Characteristics

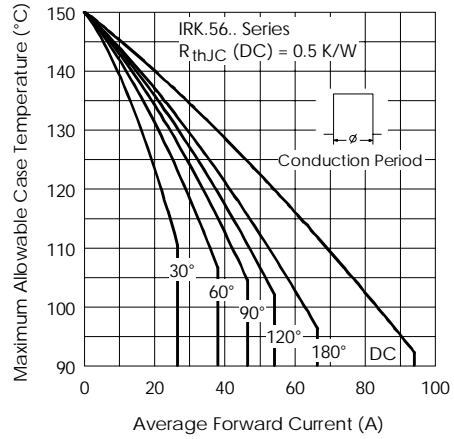

Fig. 2 - Current Ratings Characteristics

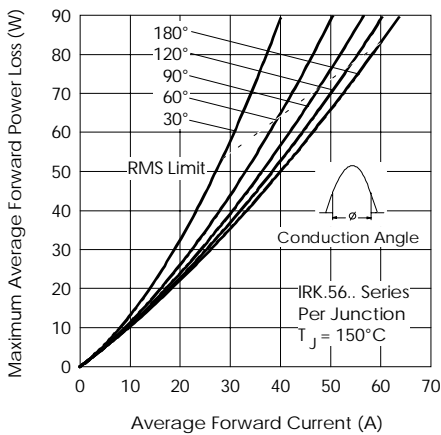

Fig. 3 - Forward Power Loss Characteristics

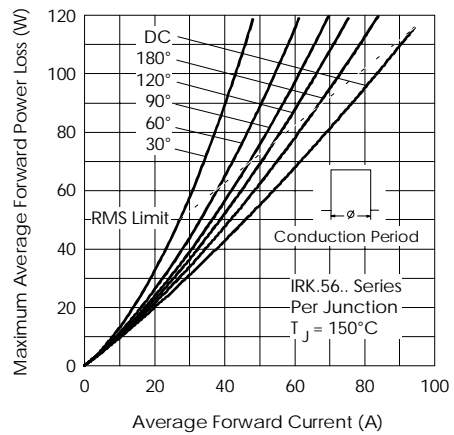

Fig. 4 - Forward Power Loss Characteristics

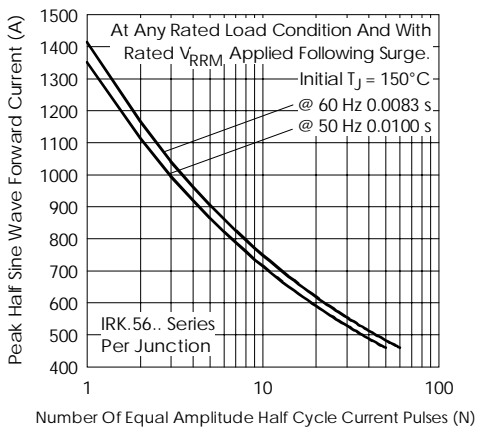

Fig. 5 - Maximum Non-Repetitive Surge Current

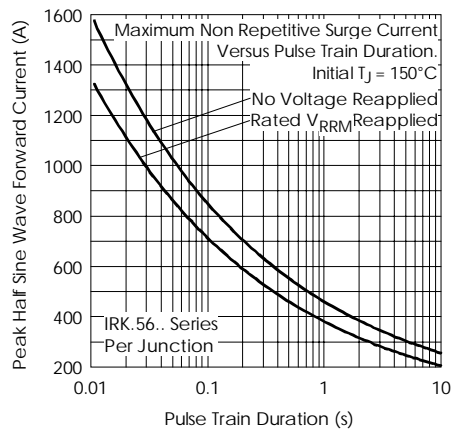

Fig. 6 - Maximum Non-Repetitive Surge Current

IRK.56, .71 Series

Bulletin I27140 rev. E 10/02

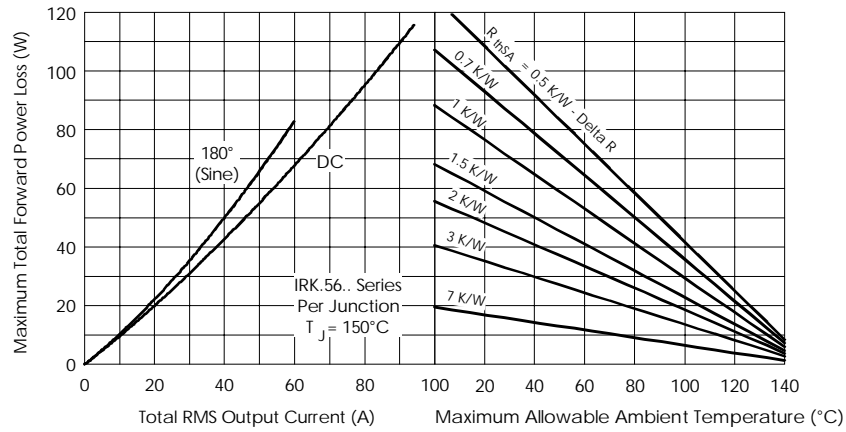

Fig. 7 - Forward Power Loss Characteristics

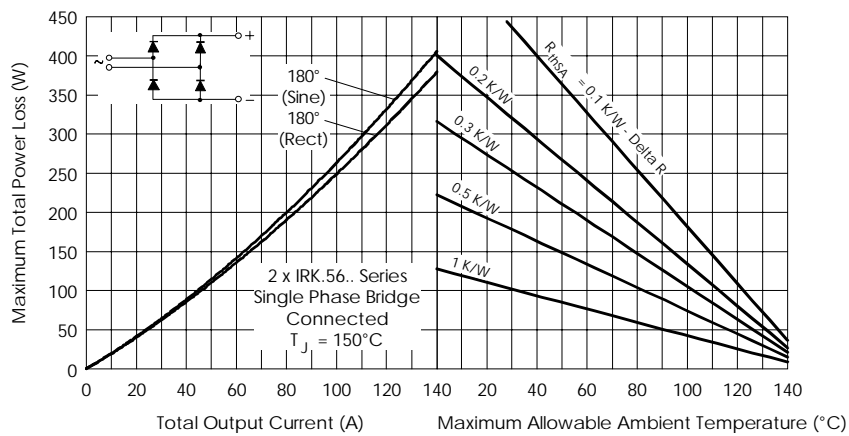

Fig. 8 - Forward Power Loss Characteristics

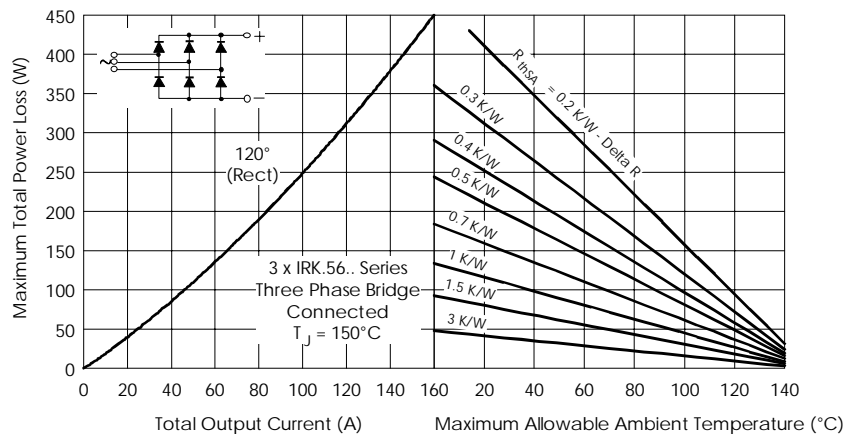

Fig. 9 - Forward Power Loss Characteristics

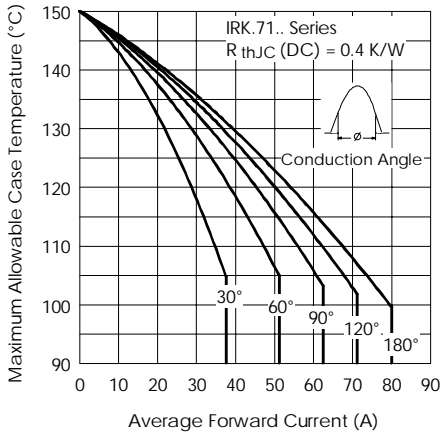

Fig. 10 - Current Ratings Characteristics

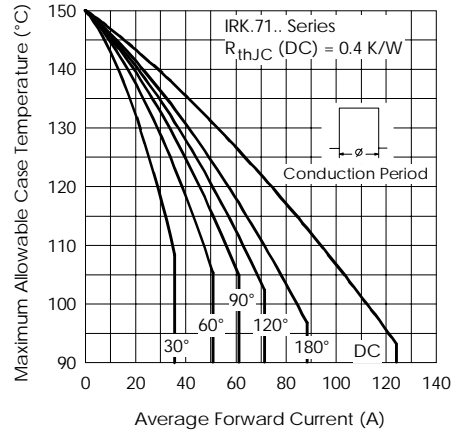

Fig. 11 - Current Ratings Characteristics

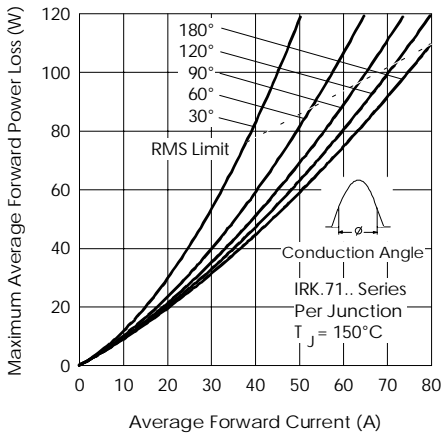

Fig. 12 - Forward Power Loss Characteristics

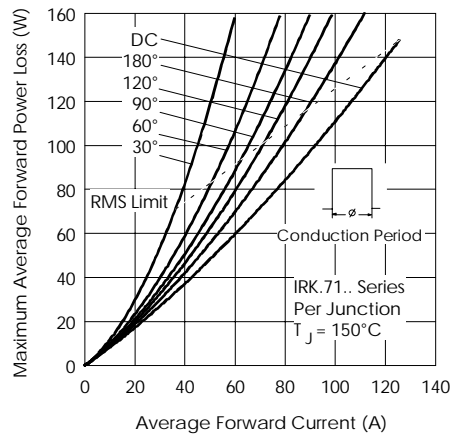

Fig. 13 - Forward Power Loss Characteristics

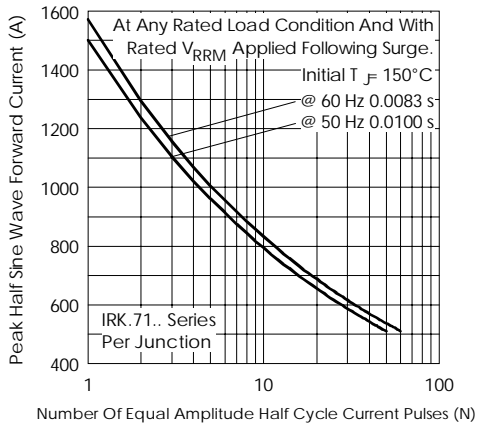

Fig. 14 - Maximum Non-Repetitive Surge Current

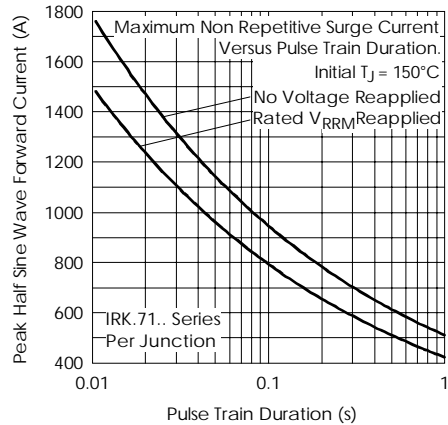

Fig. 15 - Maximum Non-Repetitive Surge Current

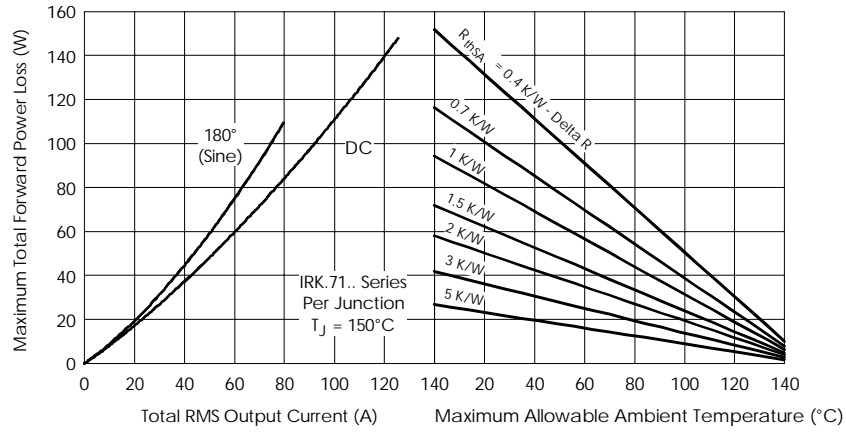

Fig. 16 - Forward Power Loss Characteristics

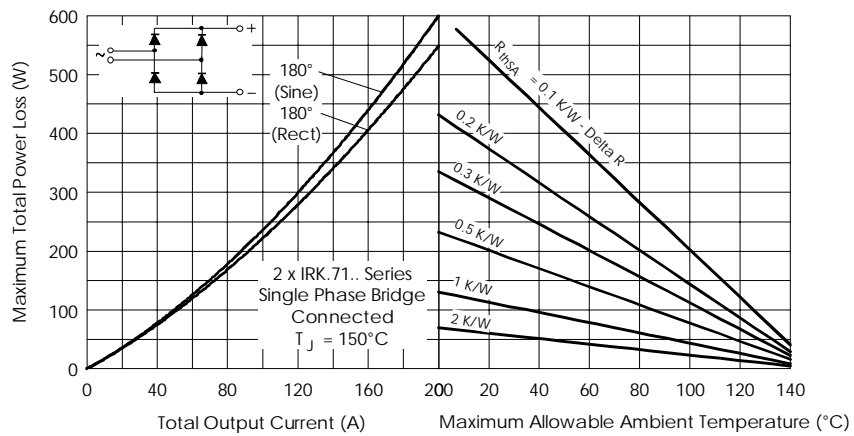

Fig. 17 - Forward Power Loss Characteristics

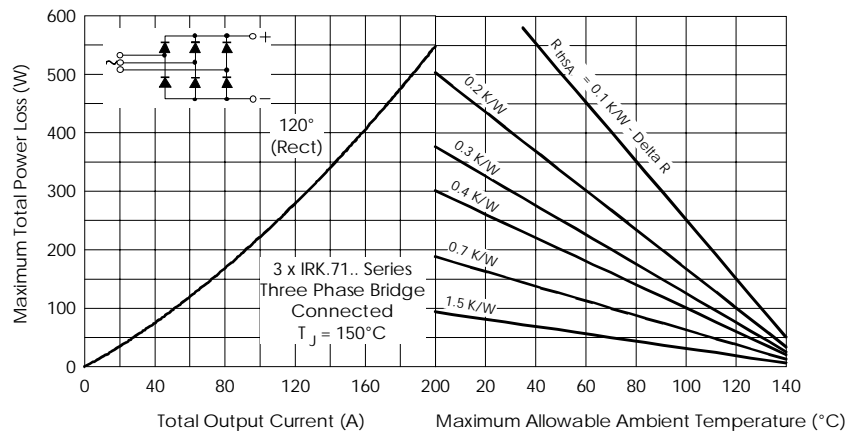

Fig. 18 - Forward Power Loss Characteristics

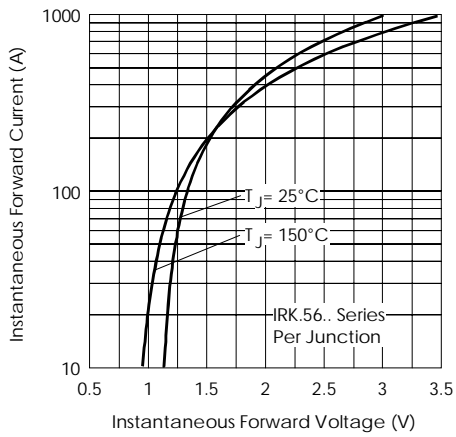

Fig. 19 - Forward Voltage Drop Characteristics

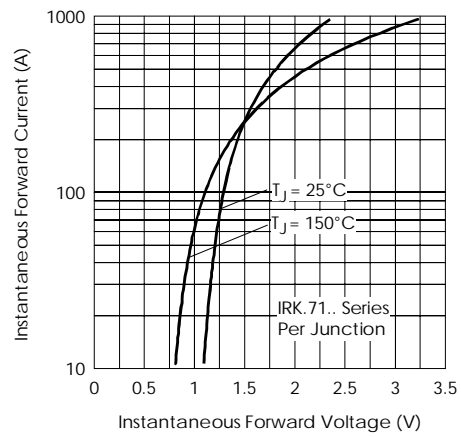

Fig. 20 - Forward Voltage Drop Characteristics

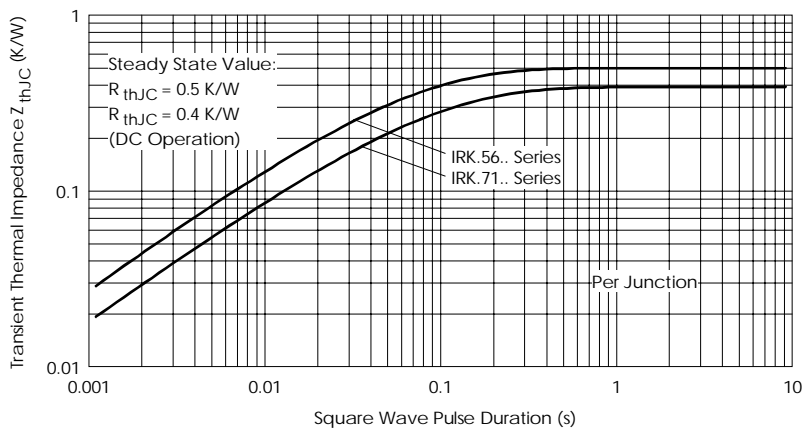

Fig. 21 - Thermal Impedance Z_{thJC} Characteristic

Data and specifications subject to change without notice.
 This product has been designed and qualified for Industrial Level.
 Qualification Standards can be found on IR's Web site.



LittleDiode supplies new, hard to find or obsolete electronic components and semiconductors all over the world.

With over two million different components listed you are sure to find the part you need.

Feel free to visit us today at our online store:

LittleDiode.com

Looking forward to providing you with the best possible service.