

# BS112/BS142 Wide Wavelength Band Type Photodiode

T-41-51

## Features

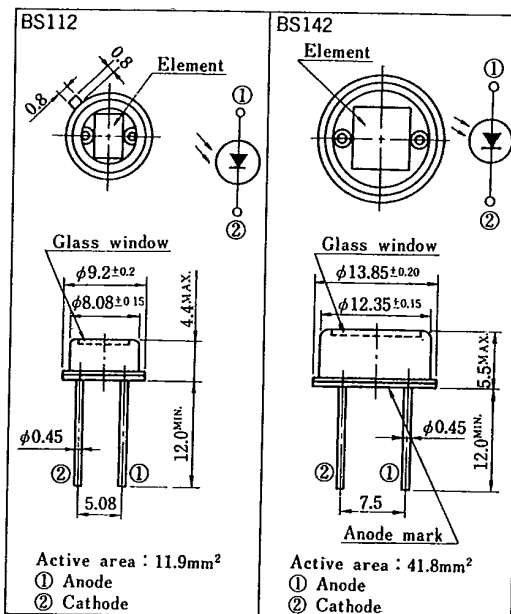
1. A wide range of sensitivity wavelength ( $\lambda$ : 350~1,150nm)
2. High reliability (hermetic seal package)
3. High sensitivity (BS112  $I_{sc}$ : MIN. 5.5 $\mu$ A, BS142  $I_{sc}$ : MIN. 18 $\mu$ A at  $E_v=100lx$ )

## Applications

1. Illuminance meters
2. Scientific color measuring instruments, such as colorimeters, flame color meters, analyzers and spectral photo meters
3. Precise optical instruments

## Outline Dimensions

(Unit : mm)



4

## Absolute Maximum Ratings

( $T_a=25^\circ\text{C}$ )

Parameter	Symbol	BS112	BS142	Unit
Reverse voltage	$V_R$	5	5	V
Operating temperature	$T_{opr}$	-10~+60	-10~+60	$^\circ\text{C}$
Storage temperature	$T_{stg}$	-20~+80	-20~+80	$^\circ\text{C}$
*1 Soldering temperature	$T_{sol}$	260	260	$^\circ\text{C}$

\*1 For 5 seconds

## Electro-optical Characteristics

( $T_a=25^\circ\text{C}$ )

Parameter	Symbol	Conditions	BS112			BS142			Unit
			MIN.	TYP.	MAX.	MIN.	TYP.	MAX.	
*2 Open circuit voltage	$V_{oc}$	$E_v=100 lx$	0.25	0.32	—	0.25	0.32	—	V
*2 Short circuit current	$I_{sc}$	$E_v=100 lx$	5.5	7.0	—	18	22	—	$\mu\text{A}$
Dark current	$I_d$	$V_R=1V$	—	$5 \times 10^{-9}$	$10^{-7}$	—	$5 \times 10^{-9}$	$10^{-7}$	A
Peak sensitivity wavelength	$\lambda_p$		—	850	—	—	850	—	nm
Sensitivity wavelength width	$\lambda$		350	—	1,150	350	—	1,150	nm
Response time	$t_r, t_f$	$R_L=1k\Omega$	—	20	—	—	27	—	$\mu\text{s}$

\*2  $E_v$ : Illuminance by CIE standard light source A (tungsten lamp)

T-41-51

Fig. 1 Spectral Sensitivity

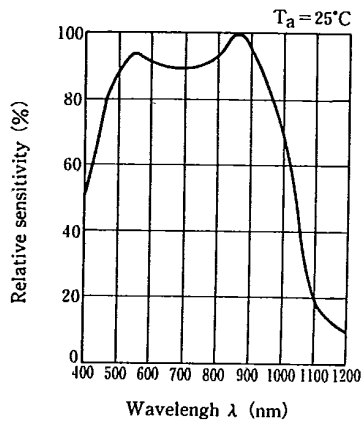


Fig. 2 Photocurrent vs. Illuminance (BS112)

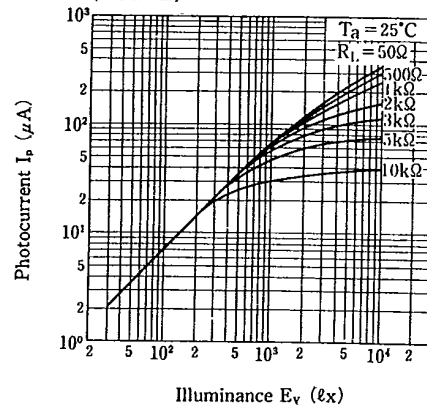


Fig. 3 Photocurrent vs. Illuminance (BS142)

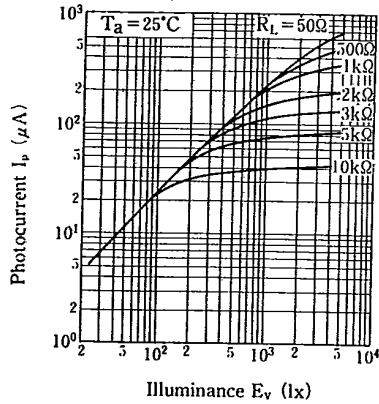


Fig. 4 Photocurrent vs. Forward Voltage (BS112)

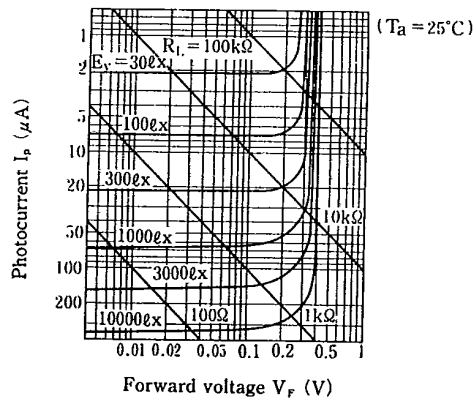


Fig. 5 Photocurrent vs. Forward Voltage (BS142)

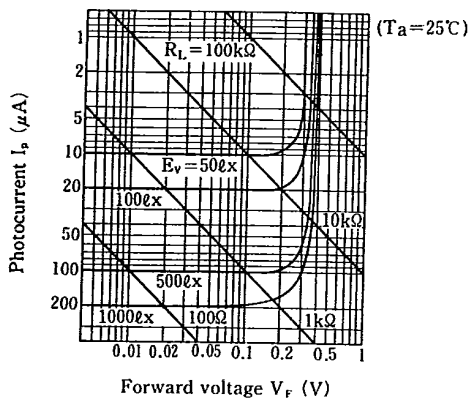
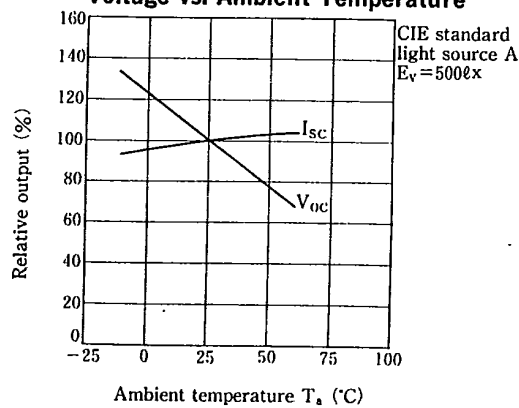
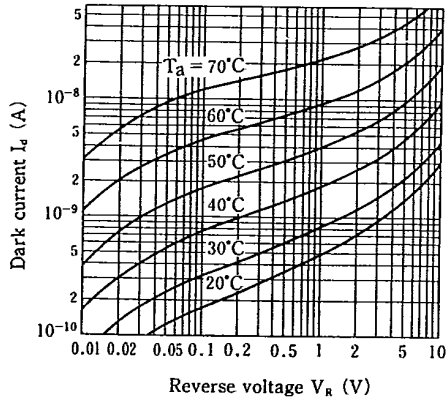


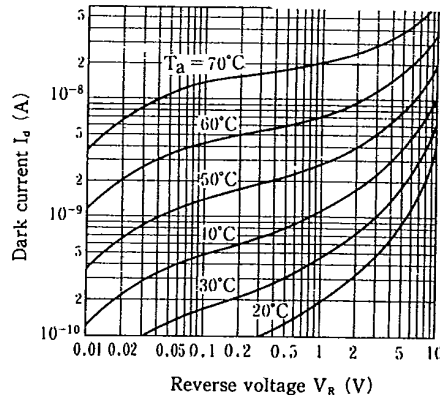
Fig. 6 Short Circuit Current, Open Circuit Voltage vs. Ambient Temperature



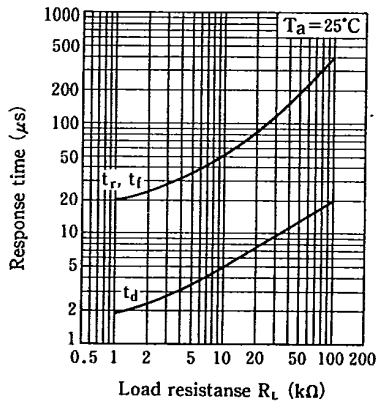
**Fig. 7 Dark Current vs. Reverse Voltage (BS112)**



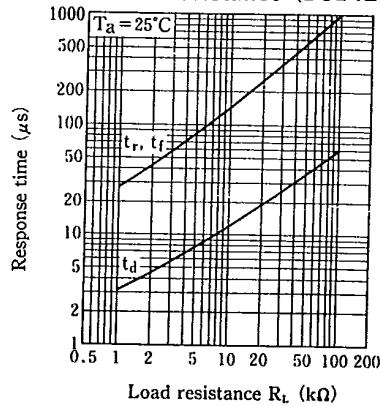
**Fig. 8 Dark Current vs. Reverse Voltage (BS142) T-41-51**



**Fig. 9 Response Time vs. Load Resistance (BS112)**

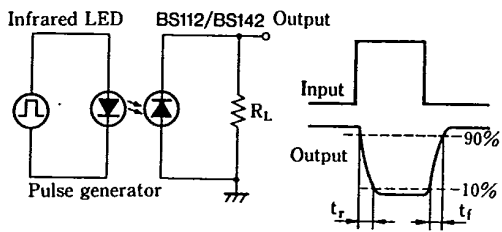


**Fig. 10 Response Time vs. Load Resistance (BS142)**



4

**Test Circuit for Response Time**



This datasheet has been downloaded from:

[www.DatasheetCatalog.com](http://www.DatasheetCatalog.com)

Datasheets for electronic components.



LittleDiode supplies new, hard to find or obsolete electronic components and semiconductors all over the world.

With over two million different components listed you are sure to find the part you need.

Feel free to visit us today at our online store:

[LittleDiode.com](http://LittleDiode.com)

Looking forward to providing you with the best possible service.