

Silicon NPN Phototransistor

Description

BPX43 is a very high sensitive silicon NPN epitaxial planar phototransistor in a standard TO-18 hermetically sealed metal case with a glass lens.

A superior linearity of photocurrent vs. irradiation makes it ideal for linear applications. A base terminal is available to enable biasing and sensitivity control.

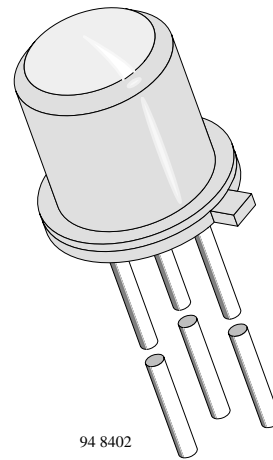

Features

- Hermetically sealed TO-18 case
- Lens window
- Angle of half sensitivity $\varphi = \pm 15^\circ$
- Exact central chip alignment
- Base terminal available
- Very high photo sensitivity
- High linearity
- Suitable for visible and near infrared radiation
- Selected into sensitivity groups

Applications

Detector for analogue and digital applications in industrial electronics, measuring and control, e.g. long range light barriers with additional optics, optical switches, alarm systems.

Absolute Maximum Ratings

$T_{amb} = 25^\circ\text{C}$

Parameter	Test Conditions	Symbol	Value	Unit
Collector Base Voltage		V_{CB0}	80	V
Collector Emitter Voltage		V_{CEO}	70	V
Emitter Base Voltage		V_{EBO}	7	V
Collector Current		I_C	50	mA
Peak Collector Current	$t_p \leq 10 \mu\text{s}$	I_{CM}	200	mA
Total Power Dissipation	$T_{amb} \leq 25^\circ\text{C}$	P_{tot}	250	mW
Junction Temperature		T_j	125	$^\circ\text{C}$
Operating Temperature Range		T_{op}	-55...+125	$^\circ\text{C}$
Storage Temperature Range		T_{stg}	-55...+125	$^\circ\text{C}$
Soldering Temperature	$t \leq 5 \text{ s}$, distance from touching border $\geq 2 \text{ mm}$	T_{sd}	260	$^\circ\text{C}$
Thermal Resistance Junction/Ambient		R_{thJA}	400	K/W
Thermal Resistance Junction/Case		R_{thJC}	150	K/W

Basic Characteristics

$T_{amb} = 25^{\circ}\text{C}$

Parameter	Test Conditions	Symbol	Min	Typ	Max	Unit
Collector Emitter Breakdown Voltage	$I_C = 1 \text{ mA}$	$V_{(BR)CE}$ O	70			V
Collector Dark Current	$V_{CE} = 25 \text{ V}, E = 0$	I_{CEO}		10	200	nA
Collector Emitter Capacitance	$V_{CE} = 0 \text{ V}, f = 1 \text{ MHz}, E = 0$	C_{CEO}		23		pF
Emitter Base Capacitance	$V_{EB} = 0 \text{ V}, f = 1 \text{ MHz}, E = 0$	C_{EBO}		47		pF
Collector Base Capacitance	$V_{CB} = 0 \text{ V}, f = 1 \text{ MHz}, E = 0$	C_{CBO}		41		pF
Collector Light Current	$E_e = 0.5 \text{ mW/cm}^2$, $\lambda = 950 \text{ nm}, V_{CE} = 5 \text{ V}$	I_{ca}	0.8			mA
Temp. Coefficient of I_{ca}	$\lambda = 950 \text{ nm}$	TK_{Ica}		1		%/K
Base Light Current	$E_e = 0.5 \text{ mW/cm}^2$, $\lambda = 950 \text{ nm}, V_{CB} = 5 \text{ V}$	I_{ba}		10		μA
Angle of Half Sensitivity		ϕ		± 15		deg
Wavelength of Peak Sensitivity		λ_p		920		nm
Range of Spectral Bandwidth		$\lambda_{0.5}$		630...1040		nm
Collector Emitter Saturation Voltage	$E_e = 0.5 \text{ mW/cm}^2$, $\lambda = 950 \text{ nm}, I_C = 0.1 \text{ mA}$	V_{CEsat}		0.15	0.3	V

Type Dedicated Characteristics

$T_{amb} = 25^{\circ}\text{C}$

Parameter	Test Conditions	Type	Symbol	Min	Typ	Max	Unit
Current Gain	$V_{CE} = 5 \text{ V}$, $I_C = 1 \text{ mA}$	BPX38-4	B		330		
		BPX38-5	B		520		
		BPX38-6	B		650		
Collector Light Current	$E_e = 0.5 \text{ mW/cm}^2$, $\lambda = 950 \text{ nm}, V_{CE} = 5 \text{ V}$	BPX38-4	I_{ca}	0.5	0.7	1.0	mA
		BPX38-5	I_{ca}	0.8	1.25	1.6	mA
		BPX38-6	I_{ca}	1.25	2		mA
Rise Time/ Fall Time	$V_{CE} = 5 \text{ V}, I_C = 1 \text{ mA}$, $R_L = 1 \text{ k}\Omega, \lambda = 820 \text{ nm}$	BPX38-4	t_r, t_f		15		μs
		BPX38-5	t_r, t_f		20		μs
		BPX38-6	t_r, t_f		25		μs

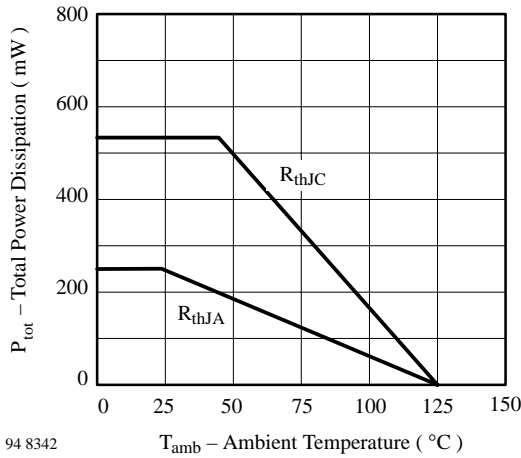
Typical Characteristics ($T_{amb} = 25^{\circ}\text{C}$ unless otherwise specified)

94 8342

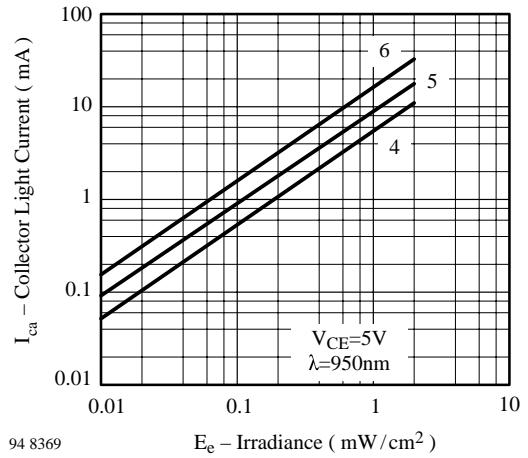
Figure 1. Total Power Dissipation vs. Ambient Temperature

94 8369

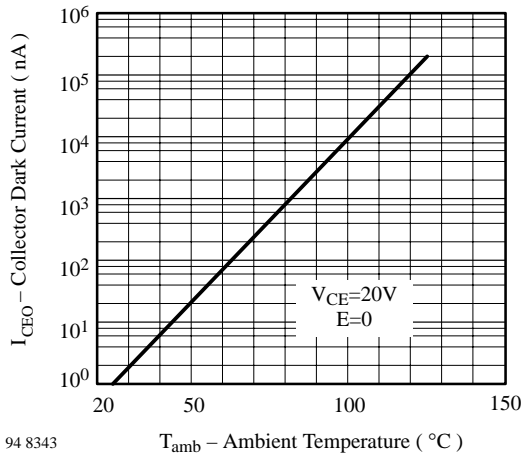
Figure 4. Collector Light Current vs. Irradiance

94 8343

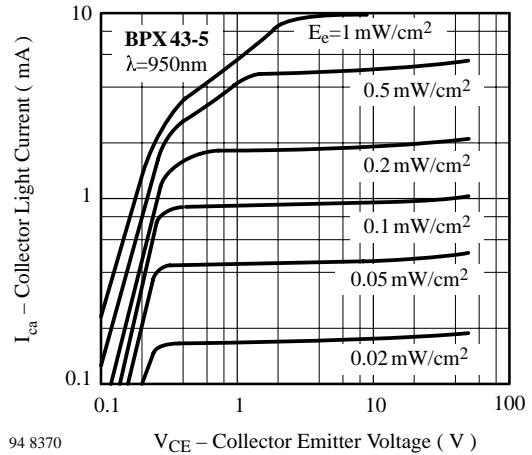
Figure 2. Collector Dark Current vs. Ambient Temperature

94 8370

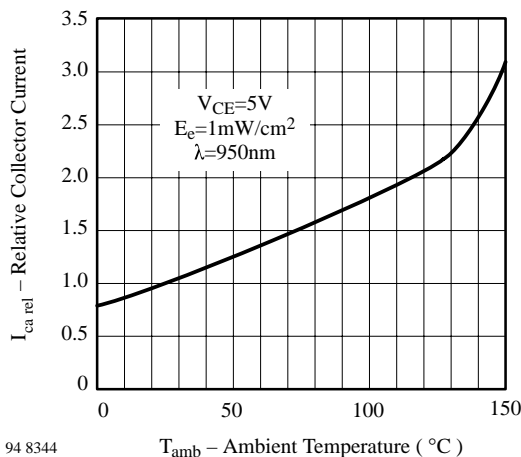
Figure 5. Collector Light Current vs. Collector Emitter Voltage

94 8344

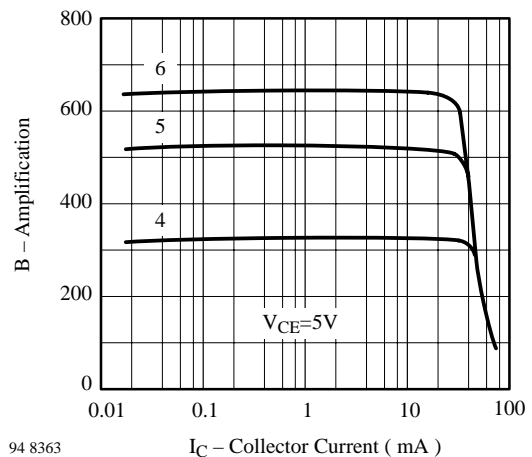
Figure 3. Relative Collector Current vs. Ambient Temperature

94 8363

Figure 6. Amplification vs. Collector Current

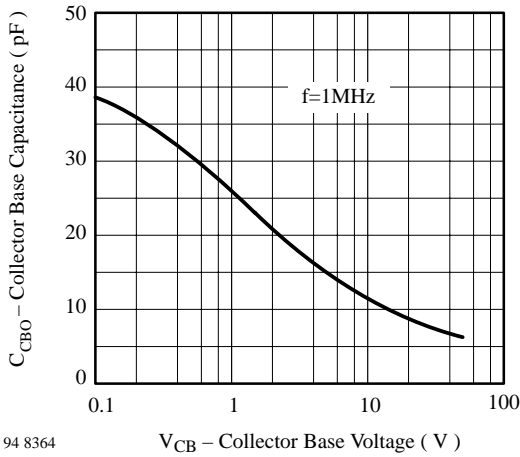

94 8364

Figure 7. Collector Base Capacitance vs. Collector Base Voltage

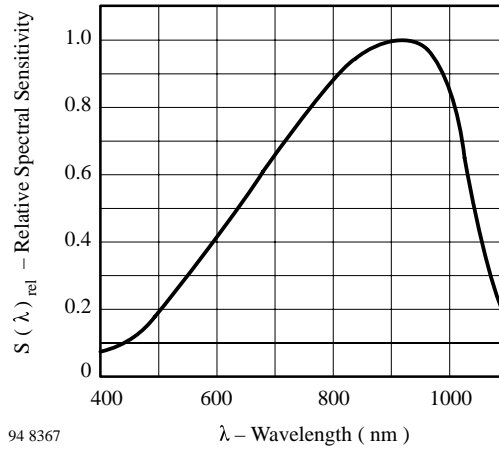

94 8367

Figure 10. Relative Spectral Sensitivity vs. Wavelength

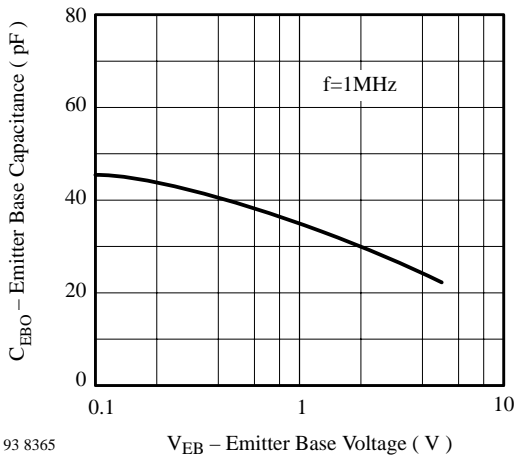

93 8365

Figure 8. Emitter Base Capacitance vs. Emitter Base Voltage

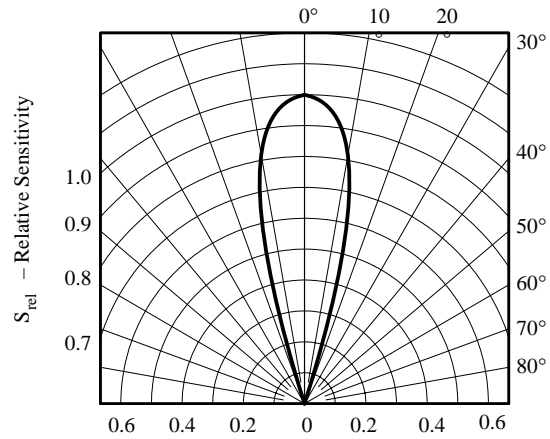

94 8371

Figure 11. Relative Radiant Sensitivity vs. Angular Displacement

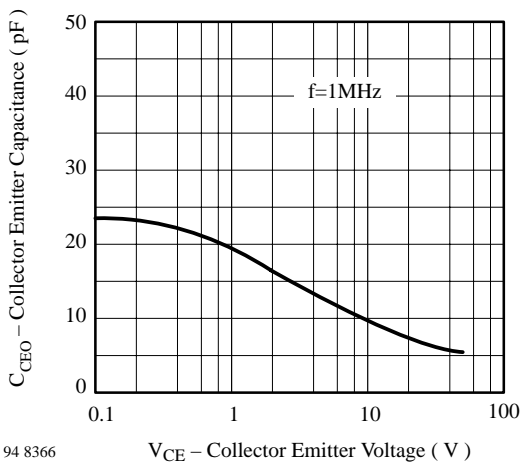

94 8366

Figure 9. Collector Emitter Capacitance vs. Collector Emitter Voltage

Dimensions in mm

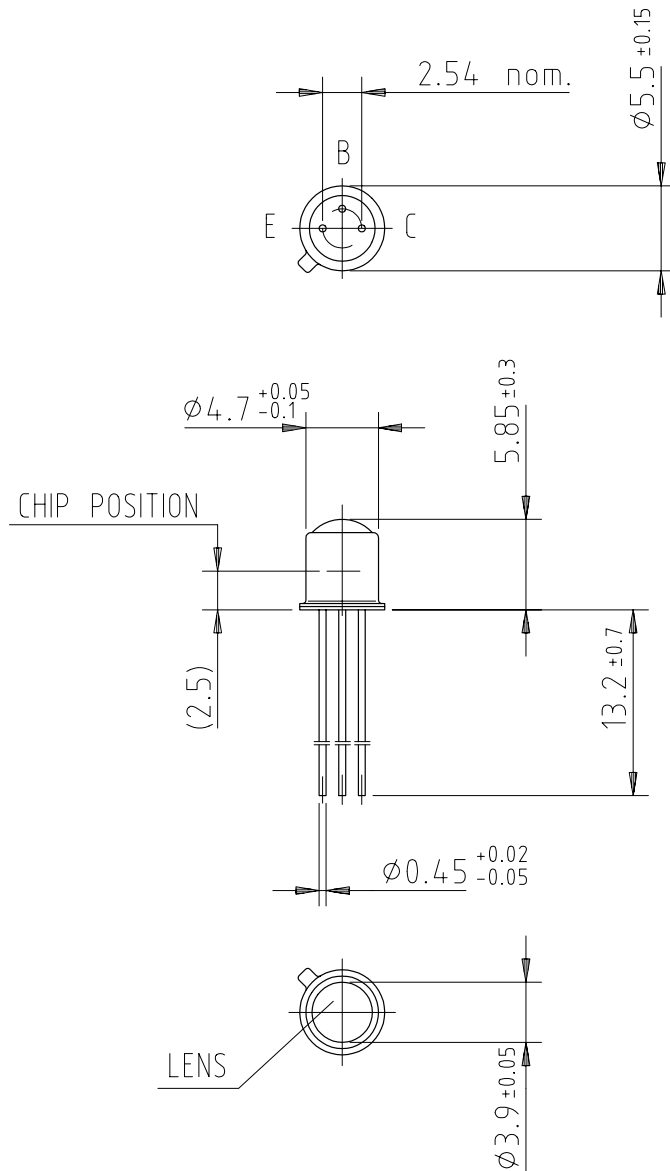

96 12178

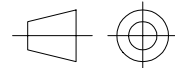

technical drawings
according to DIN
specifications

Ozone Depleting Substances Policy Statement

It is the policy of **Vishay Semiconductor GmbH** to

1. Meet all present and future national and international statutory requirements.
2. Regularly and continuously improve the performance of our products, processes, distribution and operating systems with respect to their impact on the health and safety of our employees and the public, as well as their impact on the environment.

It is particular concern to control or eliminate releases of those substances into the atmosphere which are known as ozone depleting substances (ODSs).

The Montreal Protocol (1987) and its London Amendments (1990) intend to severely restrict the use of ODSs and forbid their use within the next ten years. Various national and international initiatives are pressing for an earlier ban on these substances.

Vishay Semiconductor GmbH has been able to use its policy of continuous improvements to eliminate the use of ODSs listed in the following documents.

1. Annex A, B and list of transitional substances of the Montreal Protocol and the London Amendments respectively
2. Class I and II ozone depleting substances in the Clean Air Act Amendments of 1990 by the Environmental Protection Agency (EPA) in the USA
3. Council Decision 88/540/EEC and 91/690/EEC Annex A, B and C (transitional substances) respectively.

Vishay Semiconductor GmbH can certify that our semiconductors are not manufactured with ozone depleting substances and do not contain such substances.

We reserve the right to make changes to improve technical design and may do so without further notice.

Parameters can vary in different applications. All operating parameters must be validated for each customer application by the customer. Should the buyer use Vishay-Telefunken products for any unintended or unauthorized application, the buyer shall indemnify Vishay-Telefunken against all claims, costs, damages, and expenses, arising out of, directly or indirectly, any claim of personal damage, injury or death associated with such unintended or unauthorized use.

Vishay Semiconductor GmbH, P.O.B. 3535, D-74025 Heilbronn, Germany
Telephone: 49 (0) 7131 67 2831, Fax number: 49 (0) 7131 67 2423

This datasheet has been downloaded from:

www.DatasheetCatalog.com

Datasheets for electronic components.



LittleDiode supplies new, hard to find or obsolete electronic components and semiconductors all over the world.

With over two million different components listed you are sure to find the part you need.

Feel free to visit us today at our online store:

LittleDiode.com

Looking forward to providing you with the best possible service.