

**PACKAGE DIMENSIONS**

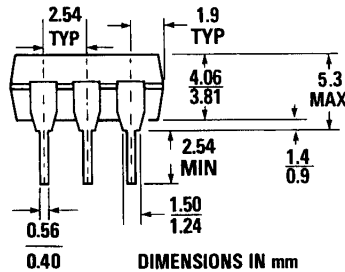

ST1603A

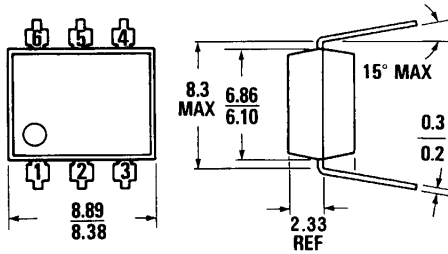
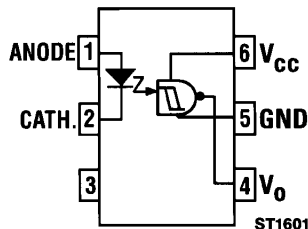

*Equivalent Circuit*

**DESCRIPTION**

The H11L series has a medium-to-high speed integrated circuit detector optically coupled to a gallium-arsenide infrared emitting diode. The output incorporates a Schmitt trigger, which provides hysteresis for noise immunity and pulse shaping. The detector circuit is optimized for simplicity of operation and utilizes an open collector output for maximum application flexibility.

**FEATURES**

- High data rate, 1 MHz typical (NRZ)
- Free from latch up and oscillation throughout voltage and temperature ranges.
- Microprocessor compatible drive
- Logic compatible output sinks 16 mA at 0.4 V maximum
- Guaranteed on/off threshold hysteresis
- High common mode rejection ratio
- Fast switching:  $t_r, t_f=100$  ns typical
- Wide supply voltage capability, compatible with all popular logic systems
- Underwriters Laboratory (UL) recognized — file #E90700

**APPLICATIONS**

- Logic to logic isolator
- Programmable current level sensor
- Line receiver—eliminate noise and transient problems
- A.C. to TTL conversion—square wave shaping
- Digital programming of power supplies
- Interfaces computers with peripherals

**ABSOLUTE MAXIMUM RATINGS**

**TOTAL PACKAGE**

Storage temperature . . . . .  $-55^{\circ}\text{C}$  to  $150^{\circ}\text{C}$   
 Operating temperature . . . . .  $-55^{\circ}\text{C}$  to  $100^{\circ}\text{C}$   
 Lead solder temperature . . . . .  $260^{\circ}\text{C}$  for 10 sec

**INPUT DIODE**

Power dissipation ( $25^{\circ}\text{C}$  ambient) . . . . . 100 mW  
 Derate linearly (above  $25^{\circ}\text{C}$  ambient) . . . . .  $1.33$  mW/ $^{\circ}\text{C}$   
 Continuous forward current . . . . . 60 mA  
 Peak forward current ( $1\ \mu\text{s}$  pulse, 300pps) . . . . . 3 A  
 Reverse voltage . . . . . 6 V

**DETECTOR**

Power dissipation (at  $25^{\circ}\text{C}$  ambient) . . . . . 150 mW  
 Derate linearly (above  $25^{\circ}\text{C}$  ambient) . . . . . 2 mW/ $^{\circ}\text{C}$   
 $V_{45}$  allowed range . . . . . 0 to 16 V  
 $V_{65}$  allowed range . . . . . 0 to 16 V  
 $I_o$  output current . . . . . 50 mA



## MICROPROCESSOR COMPATIBLE GaAs SCHMITT TRIGGER OPTOCOUPLERS

### ELECTRICAL CHARACTERISTICS ( $T_A = 0-70^\circ\text{C}$ Unless Otherwise Specified)

#### INDIVIDUAL COMPONENT CHARACTERISTICS

PARAMETER	SYMBOL	MIN.	TYP.	MAX.	UNITS	TEST CONDITIONS
<b>INPUT DIODE</b>						
Forward voltage	$V_F$		1.1	1.5	V	$I_f = 10 \text{ mA}$
	$V_F$	0.75	0.95		V	$I_f = 0.3 \text{ mA}$
Reverse current	$I_R$			10	$\mu\text{A}$	$V_R = 3 \text{ V}$
Capacitance	$C_J$			100	pF	$V = 0, f = 1 \text{ MHz}$
<b>OUTPUT DETECTOR</b>						
Operating voltage range	$V_{CC}$	3		15	V	
Supply current	$I_{c(off)}$		1.0	5.0	mA	$I_e = 0, V_{CC} = 5 \text{ V}$
Output current, high	$I_{OH}$			100	$\mu\text{A}$	$I_e = 0, V_{CC} = V_O = 15 \text{ V}$

#### TRANSFER CHARACTERISTICS

CHARACTERISTIC	SYMBOL	MIN.	TYP.	MAX.	UNITS	TEST CONDITIONS
Supply current	$I_{e(on)}$		1.6	5	mA	$I_f = 10 \text{ mA}, V_{CC} = 5 \text{ V}$
Output voltage, low	$V_{OL}$		0.2	0.4	V	$R_L = 270 \Omega, V_{CC} = 5 \text{ V}, I_e = I_{F(on)} \text{ max.}$
Turn-on threshold current	(H11L1) $I_{F(on)}$		1.0	1.6	mA	$R_L = 270 \Omega, V_{CC} = 5 \text{ V}$
	(H11L2) $I_{F(on)}$		6.0	10.0	mA	$R_L = 270 \Omega, V_{CC} = 5 \text{ V}$
	(H11L3) $I_{F(on)}$		3.0	5.0	mA	$R_L = 270 \Omega, V_{CC} = 5 \text{ V}$
Turn-off threshold current	$I_{F(off)}$	0.3	1.0		mA	$R_L = 270 \Omega, V_{CC} = 5 \text{ V}$
Hysteresis ratio	$I_{F(off)} / I_{F(on)}$	0.50	0.75	0.90		$R_L = 270 \Omega, V_{CC} = 5 \text{ V}$



## MICROPROCESSOR COMPATIBLE GaAs SCHMITT TRIGGER OPTOCOUPLERS

<b>DYNAMIC CHARACTERISTICS</b>						
PARAMETER	SYMBOL	MIN.	TYP.	MAX.	UNITS	TEST CONDITIONS
<b>SWITCHING SPEED</b>						
Turn-on time	$t_{ON}$		1.0		$\mu S$	$C=0, R_E=1.2 k\Omega$
	$t_{ON}$		0.65		$\mu S$	$C=270 pF, R_E=1.2 k\Omega$ $f \leq 100 KHz, t_p \geq 1 \mu s$
Fall time	$t_f$		0.1		$\mu S$	$C=0, R_E=1.2 k\Omega$
	$t_f$		0.05		$\mu S$	$C=270 pF, R_E=1.2 k\Omega$ $f \leq 100 KHz, t_p \geq 1 \mu s$
Turn-off time	$t_{OFF}$		2.0		$\mu S$	$C=0, R_E=1.2 k\Omega$
	$t_{OFF}$		1.20		$\mu S$	$C=270 pF, R_E=1.2 k\Omega$ $f \leq 100 KHz, t_p \geq 1 \mu s$
Rise time	$t_r$		0.1		$\mu S$	$C=0, R_E=1.2 k\Omega$
	$t_r$		0.07		$\mu S$	$C=270 pF, R_E=1.2 k\Omega$ $f \leq 100 KHz, t_p \geq 1 \mu s$
Data rate			1.0*		MHz	

<b>ISOLATION CHARACTERISTICS</b>						
CHARACTERISTIC	SYMBOL	MIN.	TYP.	MAX.	UNITS	TEST CONDITIONS
Surge isolation voltage	$V_{ISO}$	7500			$V_{PEAK}$	1 Minute
Surge isolation voltage	$V_{ISO}$	5300			$V_{RMS}$	1 Minute

\*Maximum data rate will vary depending on the bias conditions and is usually highest when  $R_E$  and  $C$  are matched to  $I_{F(ON)}$  and  $V_{CC}$  is between 3 and 15 V. With this optimized bias, most units will operate over 1.5 MHz (NRZ).

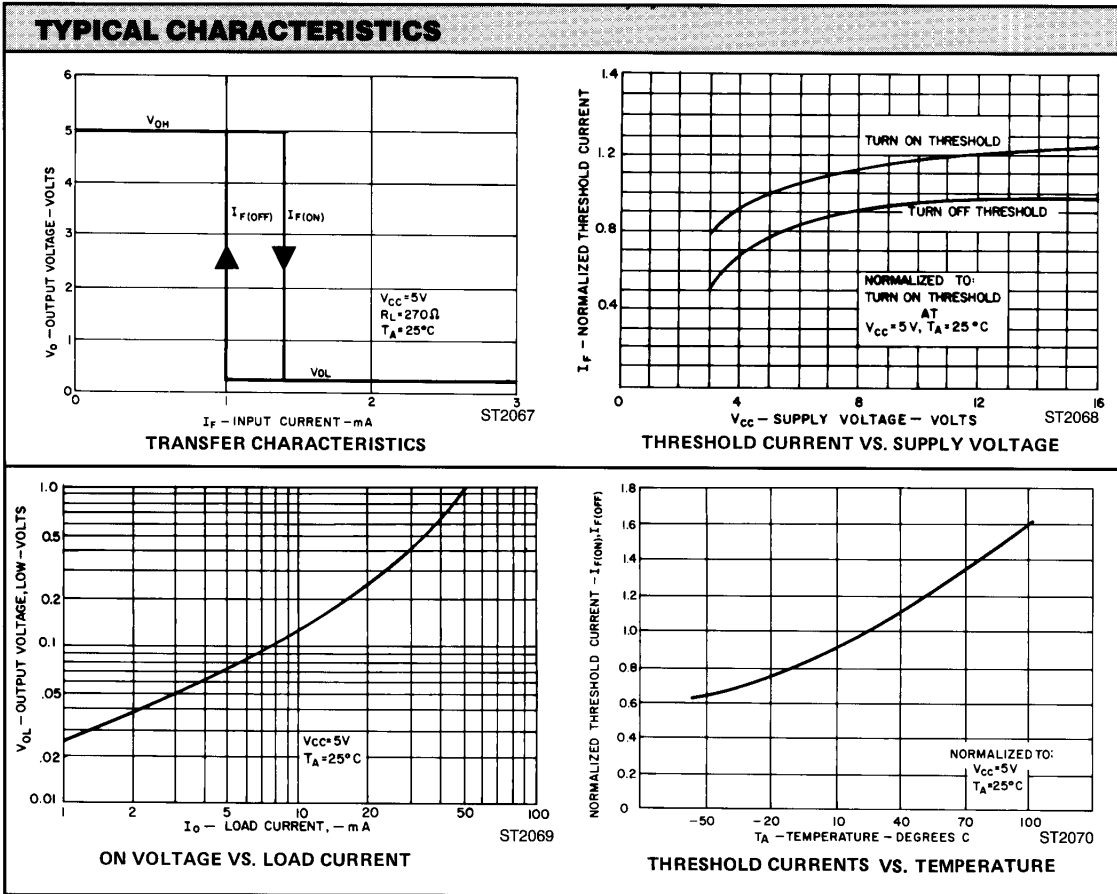
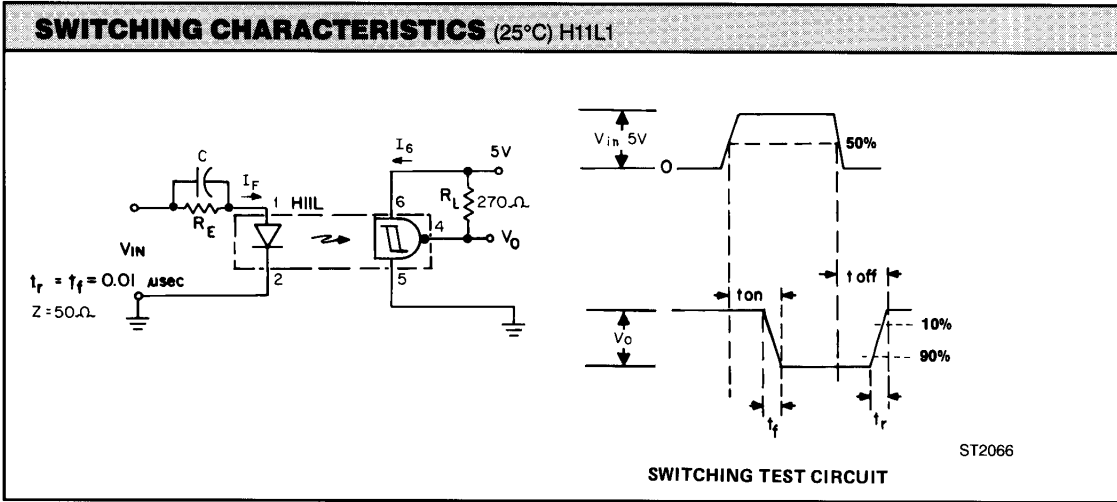

**TYPICAL CHARACTERISTICS (Cont'd)**

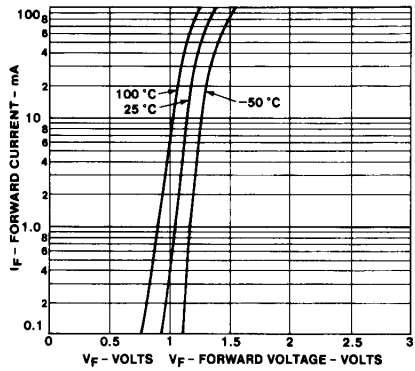

ST2015

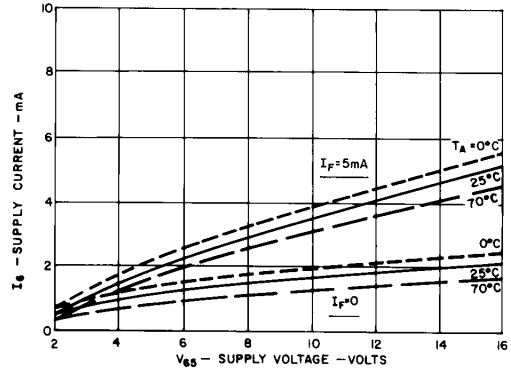

ST2016

**FORWARD VOLTAGE VS. FORWARD CURRENT**

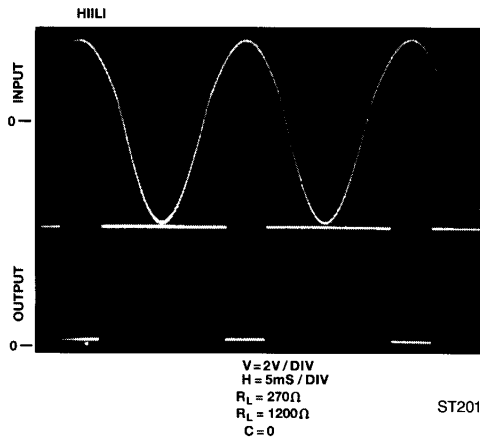

ST2017

**SUPPLY CURRENT VS. SUPPLY VOLTAGE**

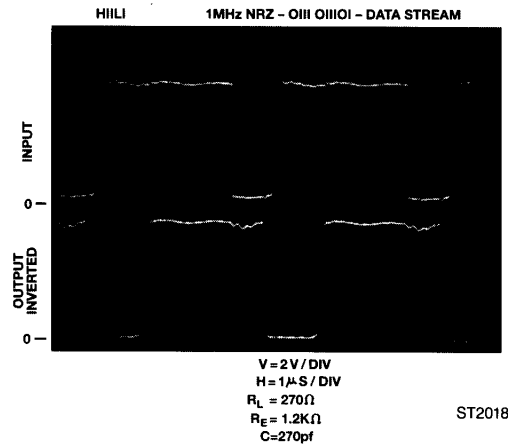

ST2018



## MICROPROCESSOR COMPATIBLE GaAs SCHMITT TRIGGER OPTOCOUPLERS

### TYPICAL APPLICATION

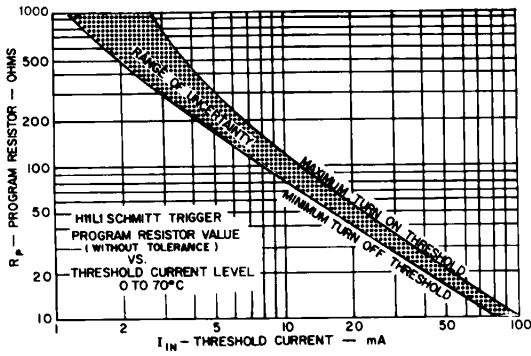

ST2019

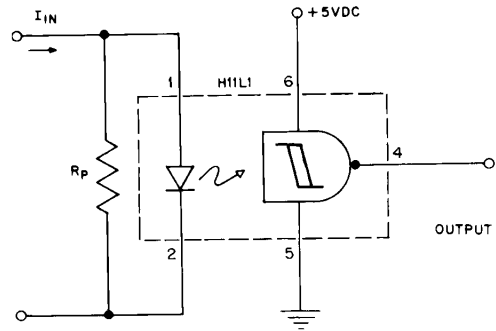

PROGRAMMABLE CURRENT  
THRESHOLD SENSING CIRCUIT



LittleDiode supplies new, hard to find or obsolete electronic components and semiconductors all over the world.

With over two million different components listed you are sure to find the part you need.

Feel free to visit us today at our online store:

[LittleDiode.com](http://LittleDiode.com)

Looking forward to providing you with the best possible service.