

# ESAC82-004K (15A)

## SCHOTTKY BARRIER DIODE

### Outline Drawing

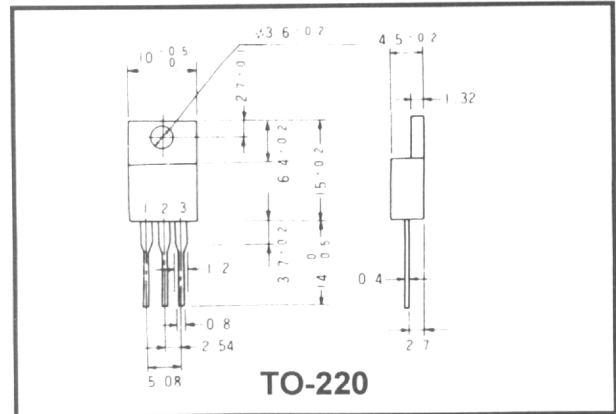

### Features

- Low  $V_F$
- Super high speed switching
- High reliability by planer design

### Applications

- High speed power switching

### Connection Diagram

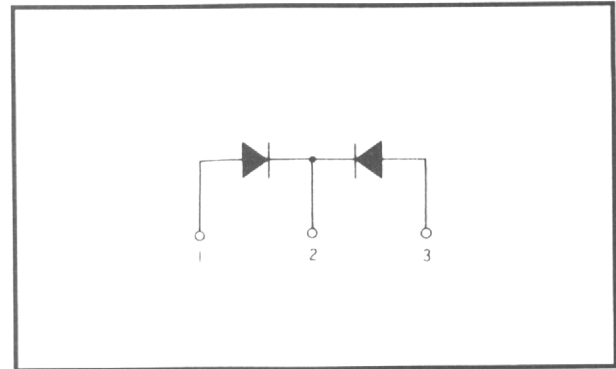

### Maximum Ratings & Characteristics

- Absolute Maximum Ratings

Items	Symbols	Conditions	Ratings	Units
Repetitive Peak Reverse Voltage	$V_{RRM}$		45	V
Non-Repetitive Peak Reverse Voltage	$V_{RSM}$	$t_w = 500\text{ns}$ , duty = 1/40	48	V
Average Forward Current	$I_O$	$T_c = 90^\circ\text{C}$ , duty 1/2, Square wave	15*	A
Surge Current	$I_{FSM}$	Sine Wave, 10ms	150	A
Operating Junction Temperature	$T_J$		-40 to +150	$^\circ\text{C}$
Storage Temperature	$T_{stg}$		-40 to +150	$^\circ\text{C}$

\* Average forward current of center tap full wave connection

- Electrical Characteristics ( $T_a = 25^\circ\text{C}$  Unless otherwise specified)

Items	Symbols	Conditions	Ratings	Units
Forward Voltage Drop	$V_F$	$I_F = 7.5\text{A}$	0.67	V
Reverse Current	$I_R$	$V_R = V_{RRM}$	1.0	mA
Thermal Resistance	$R_{th(j-c)}$	Junction to case	3.0	$^\circ\text{C/W}$

# ESAC82-004K (15A)

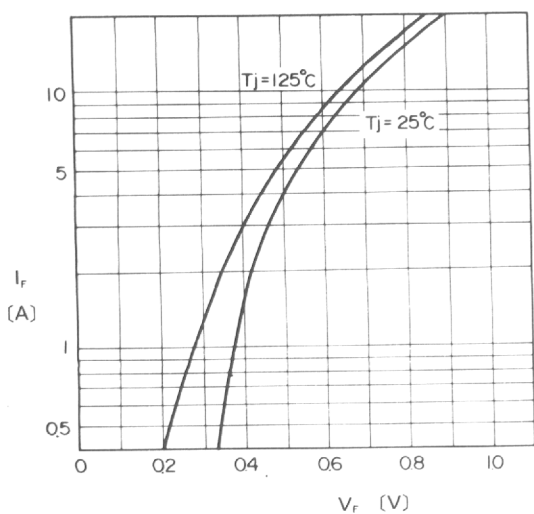

Forward Characteristics

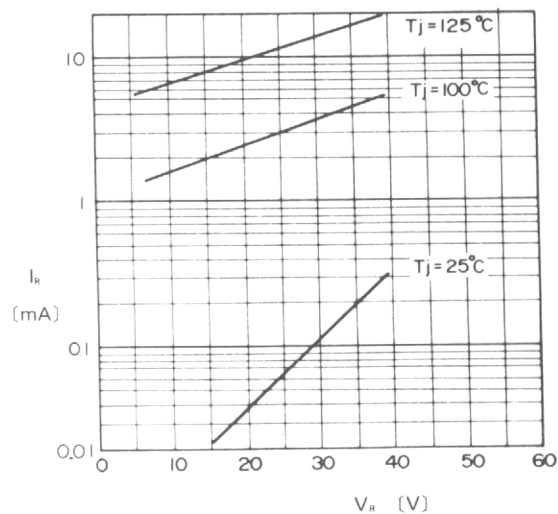

Reverse Characteristics

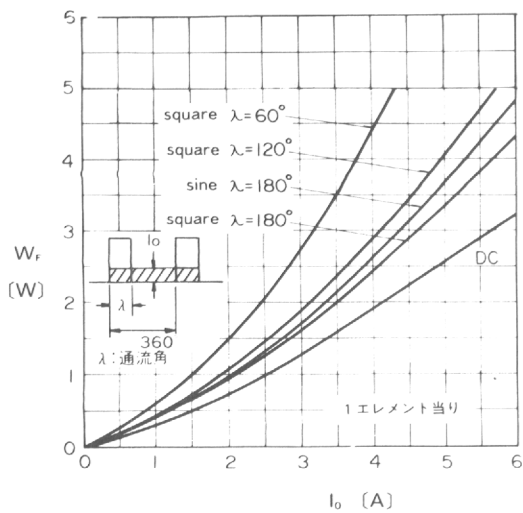

Forward Power Dissipation

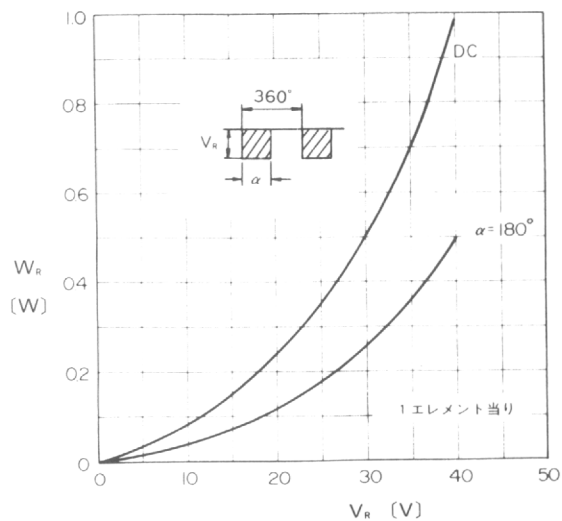

Reverse Power Dissipation

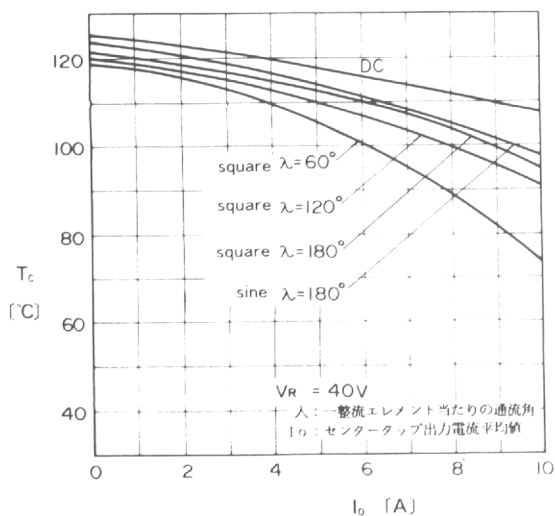

Output Current-Case Temperature

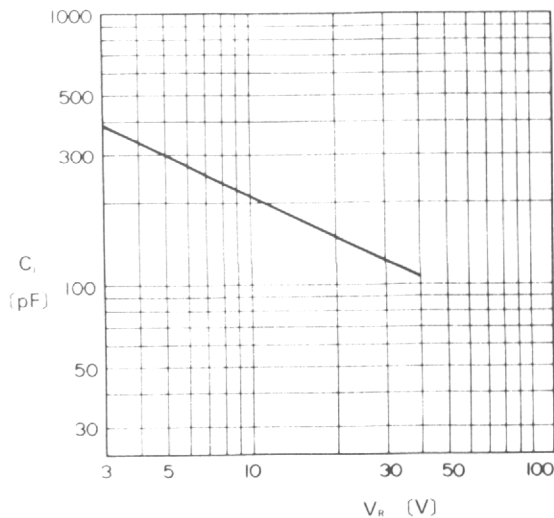

Junction Capacitance Characteristics



LittleDiode supplies new, hard to find or obsolete electronic components and semiconductors all over the world.

With over two million different components listed you are sure to find the part you need.

Feel free to visit us today at our online store:

[LittleDiode.com](http://LittleDiode.com)

Looking forward to providing you with the best possible service.