

Schottky Rectifier

SBT6040 — SBT6050

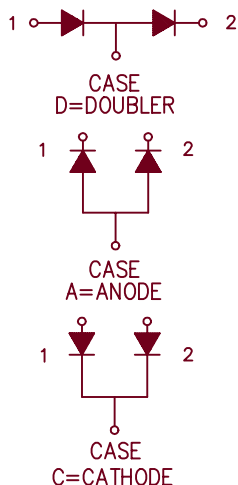
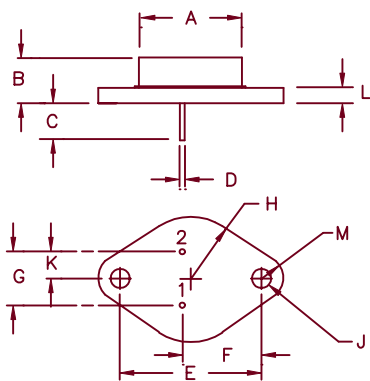

Dim.	Inches		Millimeter		Notes
	Minimum	Maximum	Minimum	Maximum	
A	—	.875	—	22.23	Dia.
B	.250	.450	6.35	11.43	
C	.435	—	11.05	—	
D	.057	.065	1.45	1.65	Dia.
E	1.177	1.197	29.90	30.40	
F	.655	.675	16.64	17.15	
G	.420	.440	10.67	11.18	
H	—	.525	—	13.34	Rad.
J	.151	.161	3.84	4.09	Dia.
K	.205	.225	5.21	5.72	
L	—	.135	—	3.43	
M	—	.180	—	4.57	Rad.

TO-204AE (LARGE PIN TO-3)

Microsemi Catalog Number	Industry Part Number	Working Peak Reverse Voltage	Repetitive Peak Reverse Voltage
SBT6040*	60CDQ035	35V	35V
SBT6045*	60CDQ040	40V	40V
SBT6045*	60CDQ045	45V	45V
SBT6050*		50V	50V

*Add D, C, or A

- Schottky Barrier Rectifier
- Guard Ring Protection
- 175°C Operation
- VRRM – 40 to 50V
- 60 Amperes
- Reverse Energy Tested

Electrical Characteristics Per Leg		
Average forward current per leg	I _{F(AV)} 30 Amps	T _C = 147°C, square wave, R _{θJC} = 1.2°C/W
Average forward current per leg	I _{F(AV)} 30 Amps	T _C = 130°C, square wave, R _{θJC} = 2.0°C/W
Maximum surge current	I _{FSM} 600 Amps	8.3 ms, half sine T _J = 175°C
Max repetitive peak reverse current	I _{R(OV)} 2 Amps	f = 1 KHz, 25°C, 1 μsec square wave
Max peak forward voltage	V _{FM} .55 Volts	I _{FM} = 30A: T _J = 175°C*
Max peak forward voltage	V _{FM} .68 Volts	I _{FM} = 30A: T _J = 25°C*
Max peak reverse current	I _{RM} 15 mA	V _{RRM} , T _J = 125°C*
Max peak reverse current	I _{RM} 1.2 mA	V _{RRM} , T _J = 25°C
Typical junction capacitance per leg	C _J 1800 pF	V _R = 5.0V, T _J = 25°C

*Pulse test: Pulse width 300 μsec, Duty cycle 2%

Thermal and Mechanical Characteristics		
Operating junction temp range	T _{SG}	-65°C to 175°C
Storage temp range	T _J	-65°C to 175°C
Maximum thermal resistance (standard polarity)	R _{θJC}	1.2°C/W Junction to case
Maximum thermal resistance (reverse polarity)	R _{θJC}	2.0°C/W Junction to case
Typical thermal resistance (greased)	R _{θCS}	0.5°C/W Case to sink
Weight		1.0 ounces (28 grams) typical

7-19-01 Rev. 2

SBT6040 — SBT6050

Figure 1
Typical Forward Characteristics

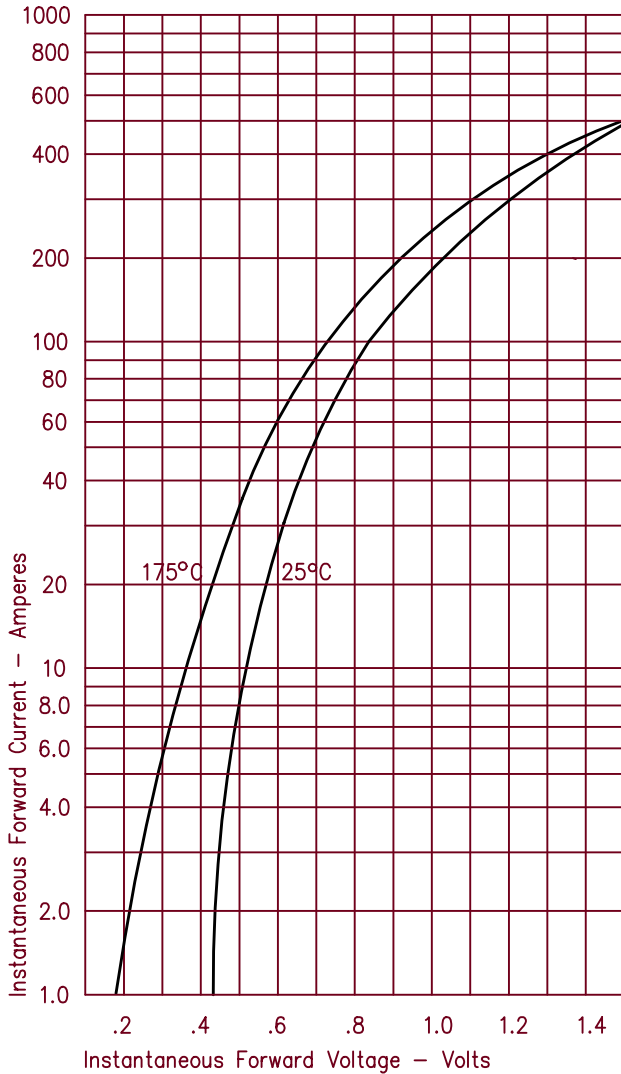

Figure 3
Typical Junction Capacitance

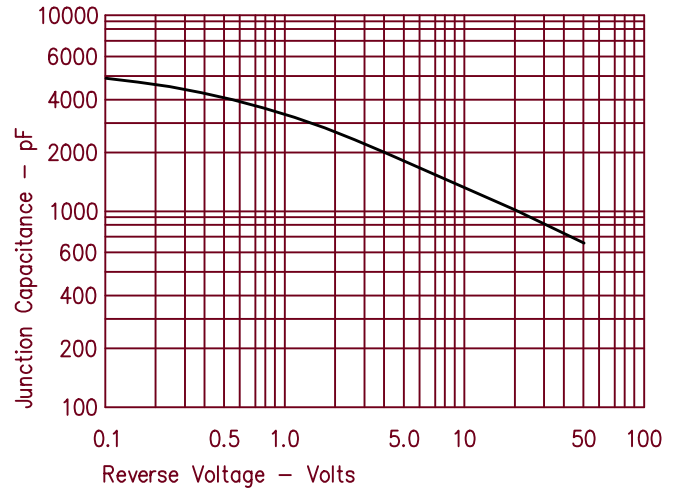

Figure 4
Forward Current Derating - Standard Polarity

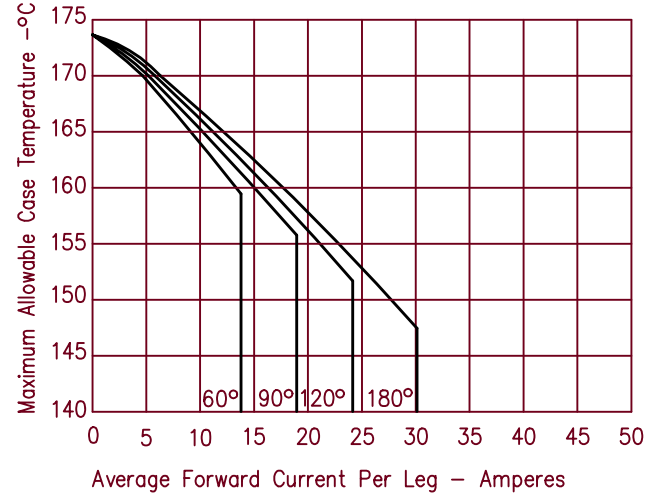

Figure 2
Typical Reverse Characteristics

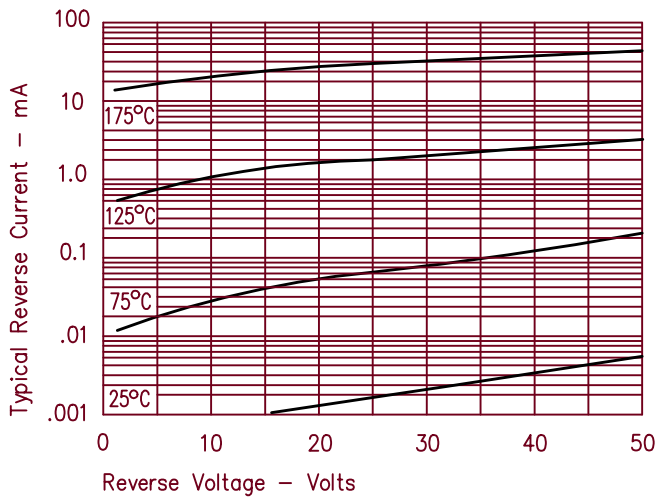
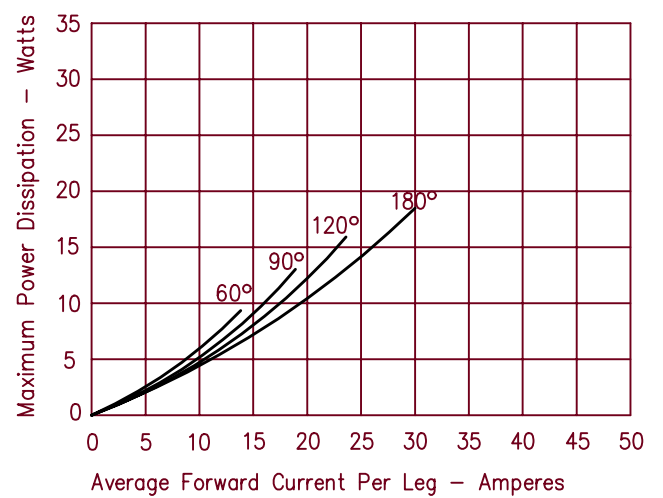

Figure 5
Maximum Forward Power Dissipation - Standard Polarity





LittleDiode supplies new, hard to find or obsolete electronic components and semiconductors all over the world.

With over two million different components listed you are sure to find the part you need.

Feel free to visit us today at our online store:

LittleDiode.com

Looking forward to providing you with the best possible service.