

International IOR Rectifier

161CMQ... SERIES

SCHOTTKY RECTIFIER

160 Amp



Major Ratings and Characteristics

Characteristics	161CMQ...	Units
$I_{F(AV)}$ Rectangular waveform	160	A
V_{RRM} range	30 to 50	V
I_{FSM} @tp = 5 μ s sine	11,500	A
V_F @80 Apk, $T_J = 125^\circ\text{C}$ (per leg)	0.63	V
T_J range	-55 to 175	$^\circ\text{C}$

Description/ Features

The 161CMQ isolated center tap Schottky rectifier module series has been optimized for low reverse leakage at high temperature. The proprietary barrier technology allows for reliable operation up to 175 $^\circ\text{C}$ junction temperature. Typical applications are in switching power supplies, converters, free-wheeling diodes, and reverse battery protection.

- 175 $^\circ\text{C}$ T_J operation
- Isolated heatsink
- Center tap module
- Multiple leads per terminal for high frequency, high current PC board mounting
- High purity, high temperature epoxy encapsulation for enhanced mechanical strength and moisture resistance
- Low forward voltage drop
- High frequency operation
- Guard ring for enhanced ruggedness and long term reliability
- Low profile, high current package

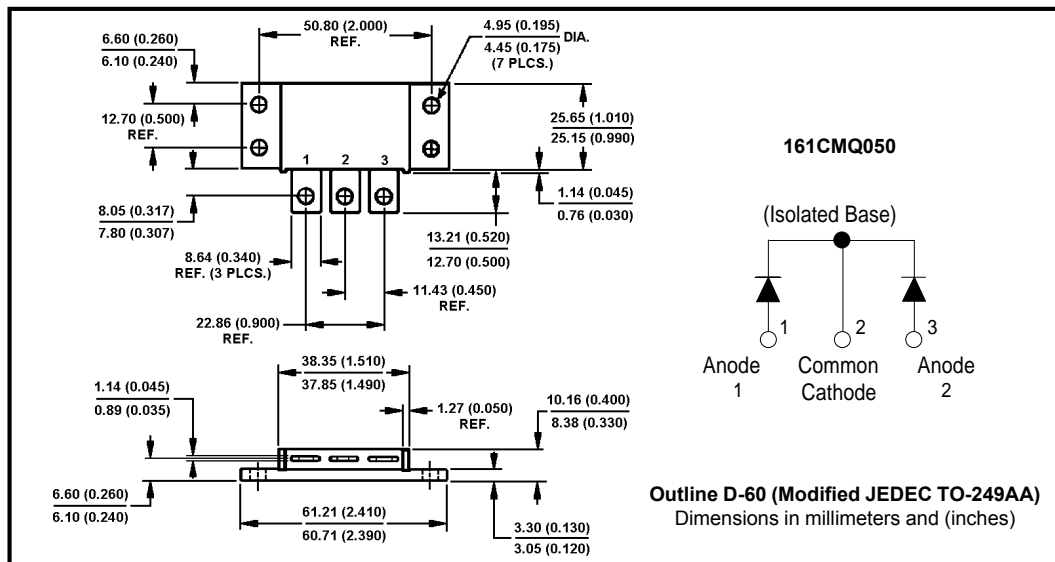

161CMQ... Series

Bulletin PD-2.174 rev. C 05/02

International
IR Rectifier

Voltage Ratings

Part number	161CMQ030	161CMQ035	161CMQ040	161CMQ045	161CMQ050
V_R Max. DC Reverse Voltage (V)	30	35	40	45	50
V_{RWM} Max. Working Peak Reverse Voltage (V)					

Absolute Maximum Ratings

Parameters	161CMQ	Units	Conditions
$I_{F(AV)}$ Max. Average Forward Current * See Fig. 5	160	A	50% duty cycle @ $T_C = 101^\circ\text{C}$, rectangular wave form
I_{FSM} Max. Peak One Cycle Non-Repetitive Surge Current (Per Leg) * See Fig. 7	11,500	A	5 μs Sine or 3 μs Rect. pulse 10ms Sine or 6ms Rect. pulse
	900		
E_{AS} Non-Repetitive Avalanche Energy (Per Leg)	108	mJ	$T_J = 25^\circ\text{C}$, $I_{AS} = 16\text{Amps}$, $L = 0.84\text{mH}$
I_{AR} Repetitive Avalanche Current (Per Leg)	16	A	Current decaying linearly to zero in 1 μsec Frequency limited by T_J max. $V_A = 1.5 \times V_R$ typical

Electrical Specifications

Parameters	161CMQ	Units	Conditions
V_{FM} Max. Forward Voltage Drop (Per Leg) * See Fig. 1 (1)	0.71	V	@ 80A
	0.88	V	@ 160A
	0.63	V	@ 80A
	0.79	V	@ 160A
I_{RM} Max. Reverse Leakage Current (Per Leg) * See Fig. 2 (1)	5	mA	$T_J = 25^\circ\text{C}$
	45	mA	$T_J = 125^\circ\text{C}$
C_T Max. Junction Capacitance (Per Leg)	2600	pF	$V_R = 5V_{DC}$, (test signal range 100Khz to 1Mhz) 25°C
L_S Typical Series Inductance (Per Leg)	8.0	nH	Measured from terminal hole to terminal hole
dv/dt Max. Voltage Rate of Change (Rated V_R)	10000	V/ μs	

(1) Pulse Width < 300 μs , Duty Cycle <2%

Thermal-Mechanical Specifications

Parameters	161CMQ	Units	Conditions
T_J Max. Junction Temperature Range	-55 to 175	$^\circ\text{C}$	
T_{stg} Max. Storage Temperature Range	-55 to 175	$^\circ\text{C}$	
R_{thJC} Max. Thermal Resistance Junction to Case (Per Leg)	1.0	$^\circ\text{C}/\text{W}$	DC operation * See Fig. 4
R_{thJC} Max. Thermal Resistance Junction to Case (Per Package)	0.50	$^\circ\text{C}/\text{W}$	DC operation
R_{thCS} Typical Thermal Resistance, Case to Heatsink	0.10	$^\circ\text{C}/\text{W}$	Mounting surface, smooth and greased
wt Approximate Weight	58 (2.0)	g (oz.)	
T Mounting Torque	Min. 40 (35)	Kg-cm (lbf-in)	
	Max. 58 (50)		
Case Style	TO-249AA	JEDEC	

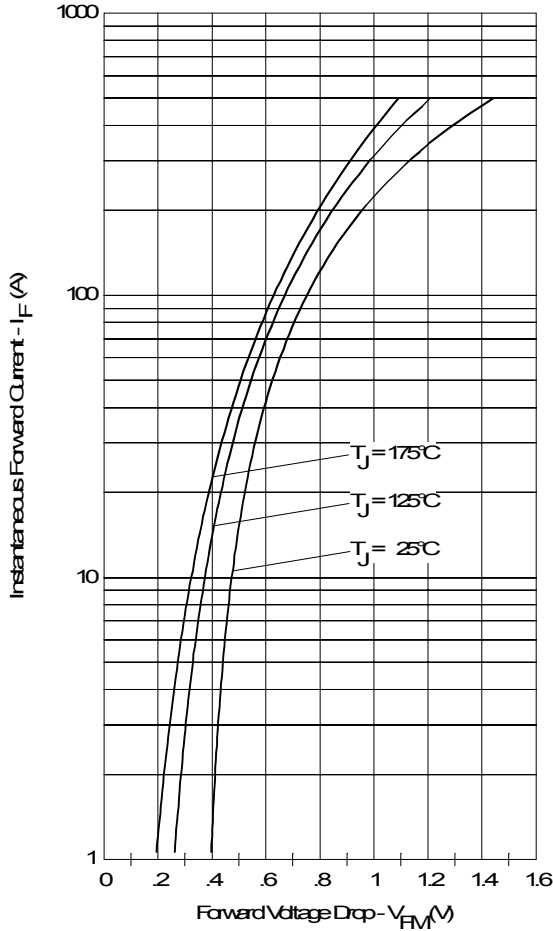

Fig. 1 - Max. Forward Voltage Drop Characteristics (Per Leg)

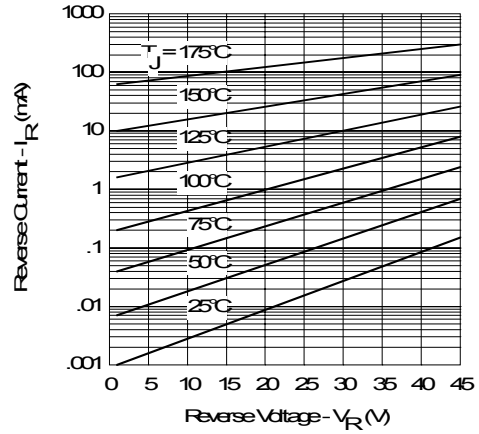

Fig. 2 - Typical Values Of Reverse Current Vs. Reverse Voltage (Per Leg)

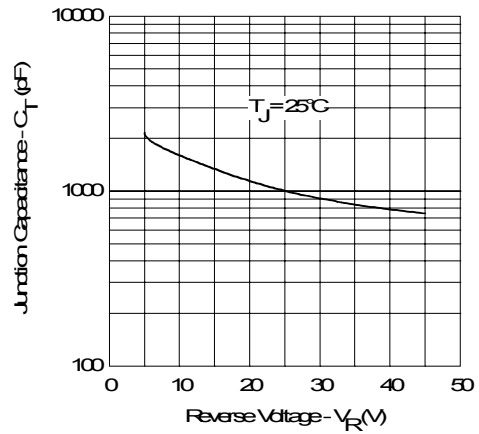

Fig. 3 - Typical Junction Capacitance Vs. Reverse Voltage (Per Leg)

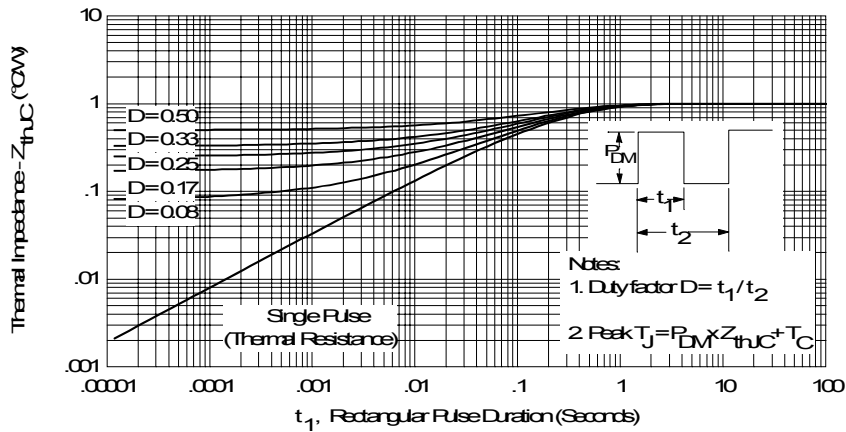

Fig. 4 - Max. Thermal Impedance Z_{thJC} Characteristics (Per Leg)

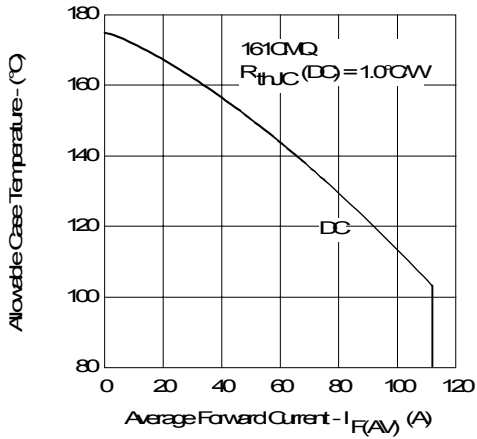

Fig. 5 - Max. Allowable Case Temperature Vs. Average Forward Current (Per Leg)

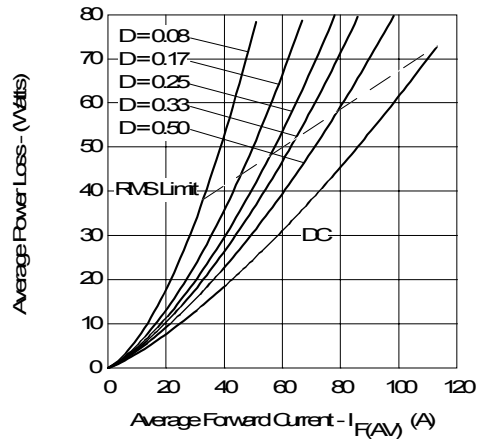

Fig. 6 - Forward Power Loss Characteristics (Per Leg)

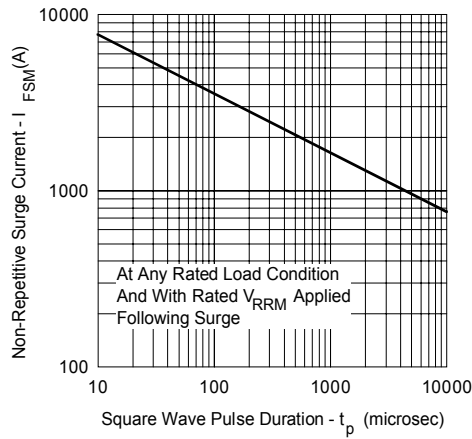

Fig. 7 - Max. Non-Repetitive Surge Current (Per Leg)

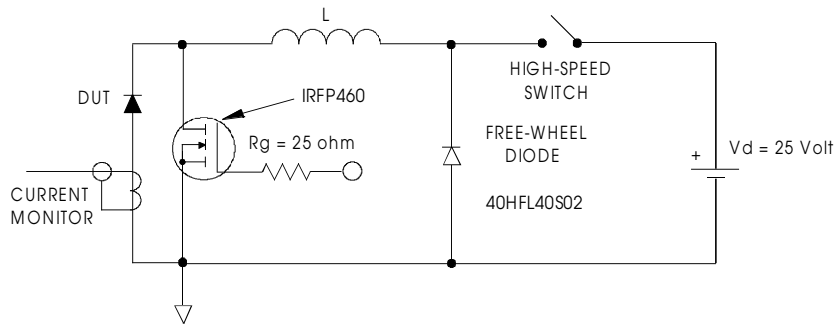

Fig. 8 - Unclamped Inductive Test Circuit

Data and specifications subject to change without notice.
This product has been designed and qualified for Industrial Level.
Qualification Standards can be found on IR's Web site.

International
IOR Rectifier

IR WORLD HEADQUARTERS: 233 Kansas St., El Segundo, California 90245, USA Tel: (310) 252-7105
TAC Fax: (310) 252-7309
Visit us at www.irf.com for sales contact information. 05/02



LittleDiode supplies new, hard to find or obsolete electronic components and semiconductors all over the world.

With over two million different components listed you are sure to find the part you need.

Feel free to visit us today at our online store:

LittleDiode.com

Looking forward to providing you with the best possible service.