

## Single-Phase Single In-Line Bridge Rectifiers

Reverse Voltage 200 to 800V  
Forward Current 15A

Case Style GSIB-5S

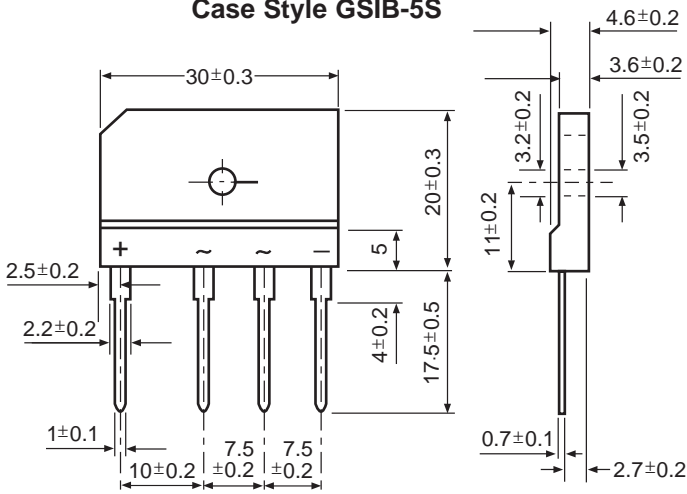

Dimensions in millimeters

### Features

- Plastic package has Underwriters Laboratory Flammability Classification 94V-0
- This series is UL listed under Recognized Component Index, file number E54214.
- High case dielectric strength of 2500 V<sub>RMS</sub>
- Ideal for printed circuit boards
- Glass passivated chip junction
- High surge current capability
- High temperature soldering guaranteed: 260°C/10 seconds, 0.375 (9.5mm) lead length, 5lbs. (2.3kg) tension

### Mechanical Data

**Case:** GSIB-5S Molded plastic body

**Terminals:** Plated leads solderable per MIL-STD-750, Method 2026

**Mounting Position:** Any<sup>(3)</sup>

**Mounting Torque:** 8 in-lbs max.

**Weight:** 0.26 oz., 7.0 g

### Maximum Ratings & Thermal Characteristics (T<sub>A</sub> = 25°C unless otherwise noted)

Parameter	Symbol	GSIB1520	GSIB1540	GSIB1560	GSIB1580	Unit
Maximum repetitive peak reverse voltage	V <sub>RRM</sub>	200	400	600	800	V
Maximum RMS voltage	V <sub>RMS</sub>	140	280	420	560	V
Maximum DC blocking voltage	V <sub>DC</sub>	200	400	600	800	V
Maximum average forward rectified output current at T <sub>C</sub> = 107°C T <sub>A</sub> = 25°C	I <sub>F(AV)</sub>	15 <sup>(1)</sup> 3.5 <sup>(2)</sup>				A
Peak forward surge current single sine-wave superimposed on rated load (JEDEC Method)	I <sub>FSM</sub>	240				A
Rating for fusing (t < 8.3ms)	I <sup>2</sup> t	240				A <sup>2</sup> sec
Maximum thermal resistance per leg	R <sub>θJA</sub> R <sub>θJC</sub>	22 <sup>(2)</sup> 1.5 <sup>(1)</sup>				°C/W
Operating junction and storage temperature range	T <sub>J</sub> , T <sub>STG</sub>	-55 to +150				°C

### Electrical Characteristics (T<sub>A</sub> = 25°C unless otherwise noted)

Parameter	Symbol	GSIB1520	GSIB1540	GSIB1560	GSIB1580	Unit
Maximum instantaneous forward voltage drop per leg at 7.5A	V <sub>F</sub>	1.00				V
Maximum DC reverse current at rated DC blocking voltage per leg	I <sub>R</sub>	10 250				μA

**Notes:**

- (1) Unit case mounted on Al plate heatsink.
- (2) Units mounted on P.C.B. without heatsink
- (3) Recommended mounting position is to bolt down on heatsink with silicone thermal compound for maximum heat transfer with #6 screw

**Ratings and Characteristic Curves** ( $T_A = 25^\circ\text{C}$  unless otherwise noted)

**Derating Curve Output Rectified Current**

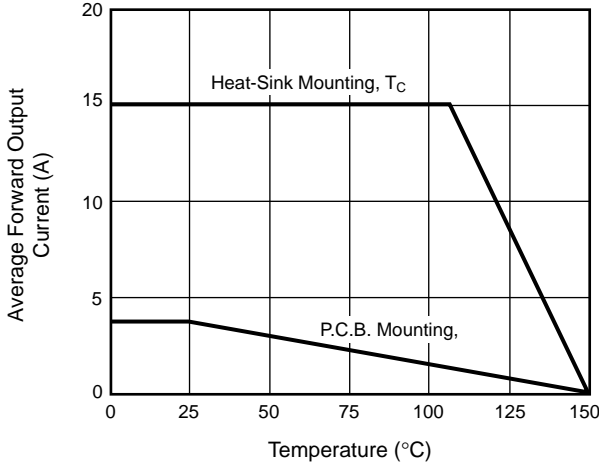

**Maximum Non-Repetitive Peak Forward Surge Current Per Leg**

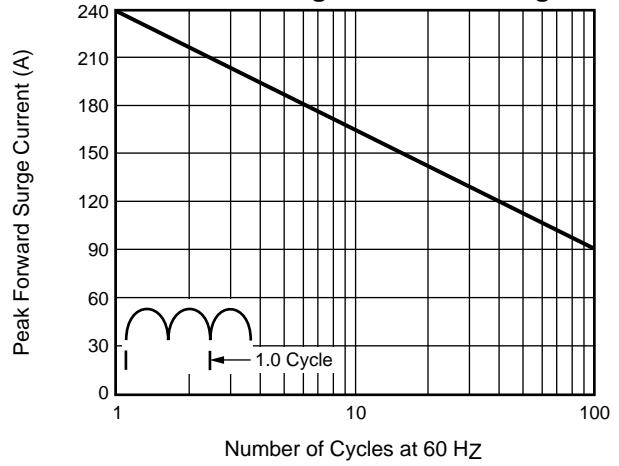

**Typical Forward Characteristics Per Leg**

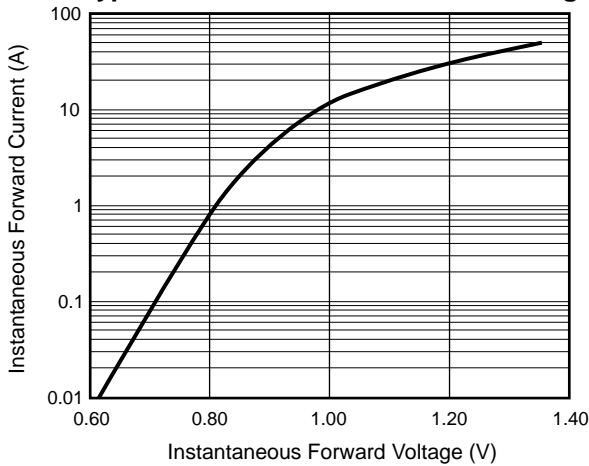

**Typical Reverse Characteristics Per Leg**

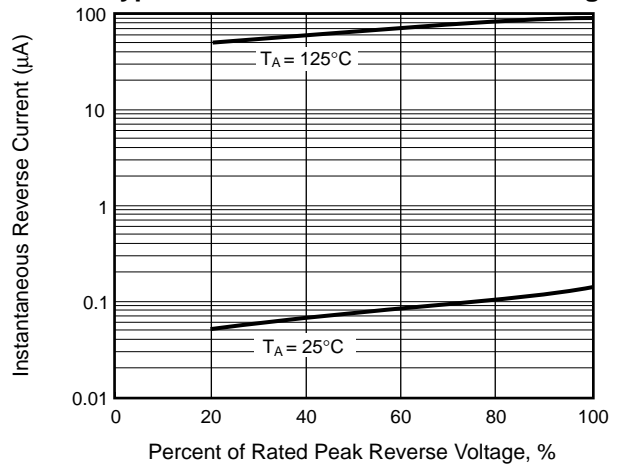

**Typical Junction Capacitance Per Leg**

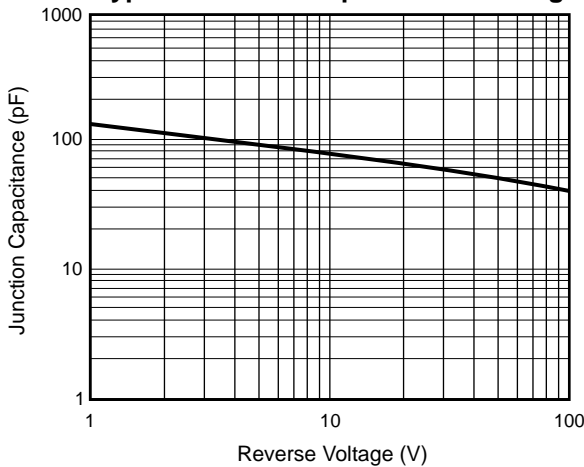

**Typical Transient Thermal Impedance**

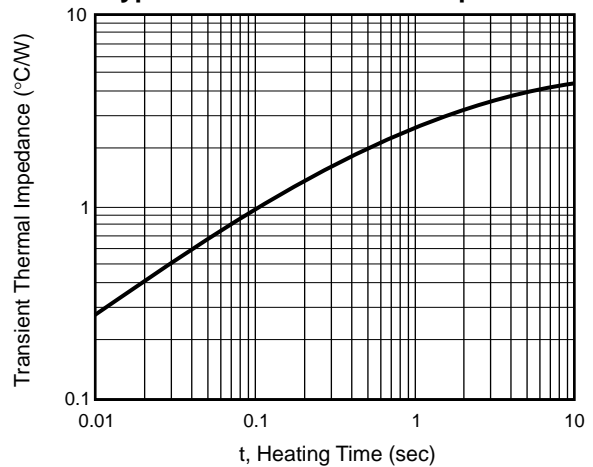



LittleDiode supplies new, hard to find or obsolete electronic components and semiconductors all over the world.

With over two million different components listed you are sure to find the part you need.

Feel free to visit us today at our online store:

[LittleDiode.com](http://LittleDiode.com)

Looking forward to providing you with the best possible service.