

FEATURES

- Monolithic 20-Bit ADC
- 0.0003% Linearity Error
- 20-Bit No Missed Codes
- On-Chip Self-Calibration Circuitry
- Programmable Low-Pass Filter
 - 0.1 Hz to 10 Hz Corner Frequency
- 0 to +2.5 V or +2.5 V Analog Input Range
- 4 kSPS Output Data Rate
- Flexible Serial Interface
- Ultralow Power

APPLICATIONS

- Industrial Process Control
- Weigh Scales
- Portable Instrumentation
- Remote Data Acquisition

FUNCTIONAL BLOCK DIAGRAM

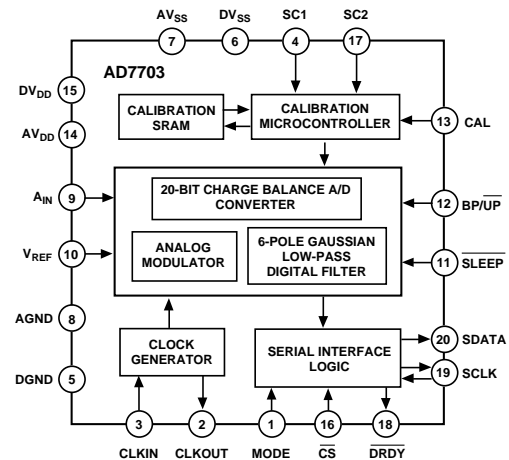

GENERAL DESCRIPTION

The AD7703 is a 20-bit ADC which uses a sigma delta conversion technique. The analog input is continuously sampled by an analog modulator whose mean output duty cycle is proportional to the input signal. The modulator output is processed by an on-chip digital filter with a six-pole Gaussian response, which updates the output data register with 20-bit binary words at word rates up to 4 kHz. The sampling rate, filter corner frequency and output word rate are set by a master clock input that may be supplied externally, or by an on-chip gate oscillator.

The inherent linearity of the ADC is excellent, and endpoint accuracy is ensured by self-calibration of zero and full scale which may be initiated at any time. The self-calibration scheme can also be extended to null system offset and gain errors in the input channel.

The output data is accessed through a serial port, which has two synchronous modes suitable for interfacing to shift registers or the serial ports of industry standard microcontrollers.

CMOS construction ensures low power dissipation, and a power down mode reduces the idle power consumption to only 10 μ W.

PRODUCT HIGHLIGHTS

1. The AD7703 offers 20-bit resolution coupled with outstanding 0.0003% accuracy.
2. No missing codes ensures true, usable, 20-bit dynamic range, removing the need for programmable gain and level-setting circuitry.
3. The effects of temperature drift are eliminated by on-chip self-calibration, which removes zero and gain error. External circuits can also be included in the calibration loop to remove system offsets and gain errors.
4. A flexible synchronization allows the AD7703 to interface directly to the serial ports of industry standard microcontrollers and DSP processors.
5. Low operating power consumption and an ultralow power standby mode make the AD7703 ideal for loop powered remote sensing applications, or battery-powered portable instruments.

REV. D

Information furnished by Analog Devices is believed to be accurate and reliable. However, no responsibility is assumed by Analog Devices for its use, nor for any infringements of patents or other rights of third parties which may result from its use. No license is granted by implication or otherwise under any patent or patent rights of Analog Devices.

© Analog Devices, Inc., 1996

One Technology Way, P.O. Box 9106, Norwood, MA 02062-9106, U.S.A.
Tel: 617/329-4700 Fax: 617/326-8703

AD7703—SPECIFICATIONS ($T_A = +25^\circ\text{C}$; $AV_{DD} = DV_{DD} = +5\text{ V}$; $AV_{SS} = DV_{SS} = -5\text{ V}$; $V_{REF} = +2.5\text{ V}$; $f_{CLKIN} = 4.096\text{ MHz}$; $BP/\overline{UP} = +5\text{ V}$; $MODE = +5\text{ V}$; A_{IN} Source Resistance = $1\text{ k}\Omega^1$ with 1 nF to AGND at A_{IN} unless otherwise noted.)

Parameter	A/S Versions ²	B Version ²	C Version ²	Units	Test Conditions/Comments	
STATIC PERFORMANCE						
Resolution	20	20	20	Bits	Guaranteed No Missing Codes	
Integral Nonlinearity, T_{MIN} to T_{MAX} $+25^\circ\text{C}$	± 0.0015	± 0.0007	± 0.0003	% FSR typ		
T_{MIN} to T_{MAX}	± 0.003	± 0.0015	± 0.0008	% FSR max		
Differential Nonlinearity, T_{MIN} to T_{MAX}	± 0.003	± 0.0015	± 0.0012	% FSR max		
Positive Full-Scale Error ³	± 0.5	± 0.5	± 0.5	LSB typ		
	± 4	± 4	± 4	LSB typ		
	± 16	± 16	± 16	LSB max		
Full-Scale Drift ⁴	$\pm 19/\pm 37$	± 19	± 19	LSB typ		
Unipolar Offset Error ³	± 4	± 4	± 4	LSB typ		
	± 16	± 16	± 16	LSB max		
Unipolar Offset Drift ⁴	± 26	± 26	± 26	LSB typ	Temp Range: 0°C to $+70^\circ\text{C}$ Specified Temp Range	
Bipolar Zero Error ³	$\pm 67 + 48/-400$	± 67	± 67	LSB typ		
	± 4	± 4	± 4	LSB typ	Temp Range: 0°C to $+70^\circ\text{C}$ Specified Temp Range	
Bipolar Zero Drift ⁴	± 16	± 16	± 16	LSB max		
	± 26	± 26	± 26	LSB typ	Temp Range: 0°C to $+70^\circ\text{C}$ Specified Temp Range	
Bipolar Negative Full-Scale Errors ³	$\pm 34 + 24/-200$	± 34	± 34	LSB typ		
	± 8	± 8	± 8	LSB typ	Temp Range: 0°C to $+70^\circ\text{C}$ Specified Temp Range	
Bipolar Negative Full-Scale Drift ⁴	± 32	± 32	± 32	LSB max		
Bipolar Negative Full-Scale Drift ⁴	$\pm 10/\pm 20$	± 10	± 10	LSB typ	Temp Range: 0°C to $+70^\circ\text{C}$ Specified Temp Range	
Noise (Referred to Output)	1.6	1.6	1.6	LSB rms typ		
DYNAMIC PERFORMANCE						
Sampling Frequency, f_S	$f_{CLKIN}/256$	$f_{CLKIN}/256$	$f_{CLKIN}/256$	Hz	For Full-Scale Input Step	
Output Update Rate, f_{OUT}	$f_{CLKIN}/1024$	$f_{CLKIN}/1024$	$f_{CLKIN}/1024$	Hz		
Filter Corner Frequency, $f_{-3\text{ dB}}$	$f_{CLKIN}/409,600$	$f_{CLKIN}/409,600$	$f_{CLKIN}/409,600$	Hz		
Settling Time to $\pm 0.0007\%$ FS	$507904/f_{CLKIN}$	$507904/f_{CLKIN}$	$507904/f_{CLKIN}$	sec		
SYSTEM CALIBRATION						
Positive Full-Scale Calibration Range	$V_{REF} + 0.1$	$V_{REF} + 0.1$	$V_{REF} + 0.1$	V max	System Calibration Applies to Unipolar and Bipolar Ranges.	
Positive Full-Scale Overrange	$V_{REF} + 0.1$	$V_{REF} + 0.1$	$V_{REF} + 0.1$	V max		
Negative Full-Scale Overrange	$-(V_{REF} + 0.1)$	$-(V_{REF} + 0.1)$	$-(V_{REF} + 0.1)$	V max	After Calibration, if $A_{IN} > V_{REF}$, the Device Will Output All 1s. If $A_{IN} < 0$ (Unipolar) or $-V_{REF}$ (Bipolar), the Device Will Output all 0s	
Maximum Offset Calibration Ranges ^{5, 6}	$-(V_{REF} + 0.1)$	$-(V_{REF} + 0.1)$	$-(V_{REF} + 0.1)$	V max		
Unipolar Input Range	$-0.4 V_{REF}$ to $+0.4 V_{REF}$	$-0.4 V_{REF}$ to $+0.4 V_{REF}$	$-0.4 V_{REF}$ to $+0.4 V_{REF}$	V max		
Bipolar Input Range	$-0.4 V_{REF}$ to $+0.4 V_{REF}$	$-0.4 V_{REF}$ to $+0.4 V_{REF}$	$-0.4 V_{REF}$ to $+0.4 V_{REF}$	V max		
Bipolar Input Range	$0.8 V_{REF}$	$0.8 V_{REF}$	$0.8 V_{REF}$	V min	Output all 0s	
Input Span ⁷	$2 V_{REF} + 0.2$	$2 V_{REF} + 0.2$	$2 V_{REF} + 0.2$	V max		
ANALOG INPUT						
Unipolar Input Range	0 to $+2.5$	0 to $+2.5$	0 to $+2.5$	Volts		
Bipolar Input Range	± 2.5	± 2.5	± 2.5	Volts		
Input Capacitance	20	20	20	pF typ		
Input Bias Current ¹	1	1	1	nA typ		
LOGIC INPUTS						
All Inputs except CLKIN						
V_{INL} , Input Low Voltage	0.8	0.8	0.8	V max		
V_{INH} , Input High Voltage	2.0	2.0	2.0	V min		
CLKIN						
V_{INL} , Input Low Voltage	0.8	0.8	0.8	V max		
V_{INH} , Input High Voltage	3.5	3.5	3.5	V min		
I_{IN} , Input Current	10	10	10	μA max		
LOGIC OUTPUTS						
V_{OL} , Output Low Voltage	0.4	0.4	0.4	V max	$I_{SINK} = 1.6\text{ mA}$ $I_{SOURCE} = 100\text{ }\mu\text{A}$	
V_{OH} , Output High Voltage	$DV_{DD} - 1$	$DV_{DD} - 1$	$DV_{DD} - 1$	V min		
Floating State Leakage Current	± 10	± 10	± 10	μA max		
Floating State Output Capacitance	9	9	9	pF typ		
POWER REQUIREMENTS						
Power Supply Voltages						
Analog Positive Supply (AV_{DD})	4.5/5.5	4.5/5.5	4.5/5.5	V min/V max	For Specified Performance	
Digital Positive Supply (DV_{DD})	4.5/ AV_{DD}	4.5/ AV_{DD}	4.5/ AV_{DD}	V min/V max		
Analog Negative Supply (AV_{SS})	$-4.5/-5.5$	$-4.5/-5.5$	$-4.5/-5.5$	V min/V max		
Digital Negative Supply (DV_{SS})	$-4.5/-5.5$	$-4.5/-5.5$	$-4.5/-5.5$	V min/V max		
Calibration Memory Retention	$-4.5/-5.5$	$-4.5/-5.5$	$-4.5/-5.5$	V min/V max		
Power Supply Voltage	2.0	2.0	2.0	V min		

Parameter	A/S Versions ²	B Version ²	C Version ²	Units	Test Conditions/Comments
STATIC PERFORMANCE					
DC Power Supply Currents ⁸					
Analog Positive Supply (AI _{DD})	3.2	3.2	3.2	mA max	Typically 2 mA
Digital Positive Supply (DI _{DD})	1.5	1.5	1.5	mA max	Typically 1 mA
Analog Negative Supply (AI _{SS})	3.2	3.2	3.2	mA max	Typically 2 mA
Digital Negative Supply (DI _{SS})	0.1	0.1	0.1	mA max	Typically 0.03 mA
Power Supply Rejection ⁹					
Positive Supplies	70	70	70	dB typ	
Negative Supplies	75	75	75	dB typ	
Power Dissipation					
Normal Operation	40	40	40	mW max	SLEEP = Logic 1, Typically 25 mW
Standby Operations ¹⁰					SLEEP = Logic 0, Typically 10 μW
A, B, C	20	20	20	μW max	
S	40	40	40	μW max	

NOTES

¹The A_{IN} pin presents a very high impedance dynamic load which varies with clock frequency. A ceramic 1 nF capacitor from the A_{IN} to AGND is necessary. Source resistance should be 750 Ω or less.

²Temperature Ranges are as follows: A, B, C Versions: -40°C to +85°C; S Version: -55°C to +125°C.

³Applies after calibration at the temperature of interest. Full-Scale Error applies for both unipolar and bipolar input ranges.

⁴Total drift over the specified temperature range after calibration at power-up at +25°C. This is guaranteed by design and/or characterization. Recalibration at any temperature will remove these errors.

⁵In unipolar mode the offset can have a negative value (-V_{REF}) such that the unipolar mode can mimic bipolar mode operation.

⁶The specifications for input overrange and for input span apply additional constraints on the offset calibration range.

⁷For unipolar mode, input span is the difference between full scale and zero scale. For bipolar mode, input span is the difference between positive and negative full-scale points. When using less than the maximum input span, the span range may be placed anywhere within the range of ±(V_{REF} + 0.1).

⁸All digital outputs unloaded. All digital inputs at 5 V CMOS levels.

⁹Applies in 0.1 Hz to 10 Hz bandwidth. PSRR at 60 Hz will exceed 120 dB due to the digital filter.

¹⁰CLKIN is stopped. All digital inputs are grounded.

Specifications subject to change without notice.

ABSOLUTE MAXIMUM RATINGS*

(T_A = +25°C unless otherwise noted)

DV _{DD} to AGND	-0.3 V to +6 V
DV _{DD} to AV _{DD}	-0.3 V to +0.3 V
DV _{SS} to AGND	+0.3 V to -6 V
AV _{DD} to AGND	-0.3 V to +6 V
AV _{SS} to AGND	+0.3 V to -6 V
AGND to DGND	-0.3 V to +0.3 V
Digital Input Voltage to DGND	-0.3 V to DV _{DD} + 0.3 V
Analog Input Voltage to AGND	AV _{SS} - 0.3 V to AV _{DD} + 0.3 V
Input Current to Any Pin Except Supplies ¹	±10 mA
Operating Temperature Range	
Industrial (A, B, C Versions)	-40°C to +85°C
Extended (S Version)	-55°C to +125°C
Storage Temperature Range	-65°C to +150°C
Lead Temperature (Soldering, 10 secs)	+300°C
Power Dissipation (DIP Package) to +75°C	450 mW
Derates above +75°C by	10 mW/°C
Power Dissipation (SOIC Package) to +75°C	250 mW
Derates above +75°C by	15 mW/°C

NOTES

*Stresses above those listed under "Absolute Maximum Ratings" may cause permanent damage to the device. This is a stress rating only and functional operation of the device at these or any other conditions above those listed in the operational sections of this specification is not implied. Exposure to absolute maximum rating conditions for extended periods may affect device reliability.

¹Transient currents of up to 100 mA will not cause SCR latch-up.

CAUTION

ESD (electrostatic discharge) sensitive device. Electrostatic charges as high as 4000 V readily accumulate on the human body and test equipment and can discharge without detection. Although this device features proprietary ESD protection circuitry, permanent damage may occur on devices subjected to high energy electrostatic discharges. Therefore, proper ESD precautions are recommended to avoid performance degradation or loss of functionality.

ORDERING GUIDE

Model	Temperature Range	Linearity Error (% FSR)	Package Options*
AD7703AN	-40°C to +85°C	0.003	N-20
AD7703BN	-40°C to +85°C	0.0015	N-20
AD7703CN	-40°C to +85°C	0.0012	N-20
AD7703AR	-40°C to +85°C	0.003	R-20
AD7703BR	-40°C to +85°C	0.0015	R-20
AD7703CR	-40°C to +85°C	0.0012	R-20
AD7703AQ	-40°C to +85°C	0.003	Q-20
AD7703BQ	-40°C to +85°C	0.0015	Q-20
AD7703CQ	-40°C to +85°C	0.0012	Q-20
AD7703SQ	-55°C to +125°C	0.003	Q-20

*N = Plastic DIP; R = SOIC; Q = Cerdip.



AD7703

TIMING CHARACTERISTICS^{1, 2} ($AV_{DD} = DV_{DD} = +5 V \pm 10\%$; $AV_{SS} = DV_{SS} = -5 V \pm 10\%$; $AGND = DGND = 0 V$; $f_{CLKIN} = 4.096 \text{ MHz}$; Input Levels: Logic 0 = 0 V, Logic 1 = DV_{DD} ; unless otherwise noted.)

Parameter	Limit at T_{MIN} , T_{MAX} (A, B, C Versions)	Limit at T_{MIN} , T_{MAX} (S Version)	Units	Conditions/Comment ⁶
f_{CLKIN} ^{3, 4}	200 5	200 5	kHz min MHz max	Master Clock Frequency: Internal Gate Oscillator Typically 4096 kHz
	200 5	200 5	kHz min MHz max	Master Clock Frequency: Externally Supplied
t_r ⁵	50	50	ns max	Digital Output Rise Time. Typically 20 ns
t_f ⁵	50	50	ns max	Digital Output Fall Time. Typically 20 ns
t_1	0	0	ns min	SC1, SC2 to CAL High Setup Time
t_2	50	50	ns min	SC1, SC2 Hold Time After CAL Goes High
t_3 ⁶	1000	1000	ns min	SLEEP High to CLKIN High Setup Time
SSC MODE				
t_4 ⁷	$3/f_{CLKIN}$	$3/f_{CLKIN}$	ns max	Data Access Time (\overline{CS} Low to Data Valid)
t_5	100	100	ns max	SCLK Falling Edge to Data Valid Delay (25 ns typ)
t_6	250	250	ns min	MSB Data Setup Time. Typically 380 ns
t_7	300	300	ns max	SCLK High Pulse Width. Typically 240 ns
t_8	790	790	ns max	SCLK Low Pulse Width. Typically 730 ns
t_9	$1/f_{CLKIN} + 200$	$1/f_{CLKIN} + 200$	ns max	SCLK Rising Edge to Hi-Z Delay ($1/f_{CLKIN} + 100 \text{ ns typ}$)
t_{10} ^{8, 9}	$4/f_{CLKIN} + 200$	$4/f_{CLKIN} + 200$	ns max	CS High to Hi-Z Delay
SEC MODE				
f_{SCLK}	5	5	MHz max	Serial Clock Input Frequency
t_{11}	35	35	ns min	SCLK High Pulse Width
t_{12}	160	160	ns min	SCLK Low Pulse Width
t_{13} ^{7, 10}	160	160	ns max	Data Access Time (\overline{CS} Low to Data Valid). Typically 80 ns
t_{14} ¹¹	150	150	ns max	SCLK Falling Edge to Data Valid Delay. Typically 75 ns
t_{15} ⁸	250	250	ns max	CS High to Hi-Z Delay
t_{16} ⁸	200	200	ns max	SCLK Falling Edge to Hi-Z Delay. Typically 100 ns

NOTES

¹Sample tested at +25°C to ensure compliance. All input signals are specified with $t_r = t_f = 5 \text{ ns}$ (10% to 90% of 5 V) and timed from a voltage level of 1.6 V.

²See Figures 1 to 6.

³CLKIN duty cycle range is 20% to 80%. CLKIN must be supplied whenever the AD7703 is not in SLEEP mode. If no clock is present in this case, the device can draw higher current than specified and possibly become uncalibrated.

⁴The AD7703 is production tested with f_{CLKIN} at 4.096 MHz. It is guaranteed by characterization to operate at 200 kHz.

⁵Specified using 10% and 90% points on waveform of interest.

⁶In order to synchronize several AD7703s together using the SLEEP pin, this specification must be met.

⁷ t_4 and t_{13} are measured with the load circuit of Figure 1 and defined as the time required for an output to cross 0.8 V or 2.4 V.

⁸ t_9 , t_{10} , t_{15} and t_{16} are derived from the measured time taken by the data outputs to change 0.5 V when loaded with the circuit of Figure 1. The measured number is then extrapolated back to remove the effects of charging or discharging the 100 pF capacitor. This means that the time quoted in the Timing Characteristics is the true bus relinquish time of the part and as such is independent of external bus loading capacitances.

⁹If CS is returned high before all 20 bits are output, the SDATA and SCLK outputs will complete the current data bit and then go to high impedance.

¹⁰If CS is activated asynchronously to \overline{DRDY} , CS will not be recognized if it occurs when \overline{DRDY} is high for four clock cycles. The propagation delay time may be as great as 4 CLKIN cycles plus 160 ns. To guarantee proper clocking of SDATA when using asynchronous CS, the SCLK input should not be taken high sooner than 4 CLKIN cycles plus 160 ns after CS goes low.

¹¹SDATA is clocked out on the falling edge of the SCLK input.

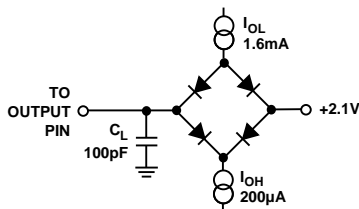

Figure 1. Load Circuit for Access Time and Bus Relinquish Time

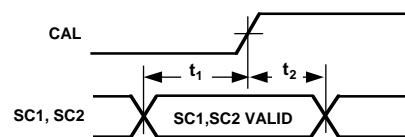

Figure 2. Calibration Control Timing

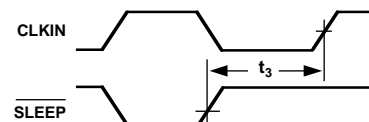

Figure 3. Sleep Mode Timing

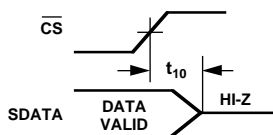

Figure 4. SSC Mode Data Hold Time

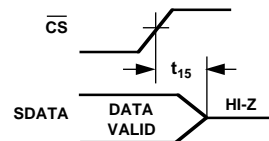

Figure 5a. SEC Mode Data Hold Time

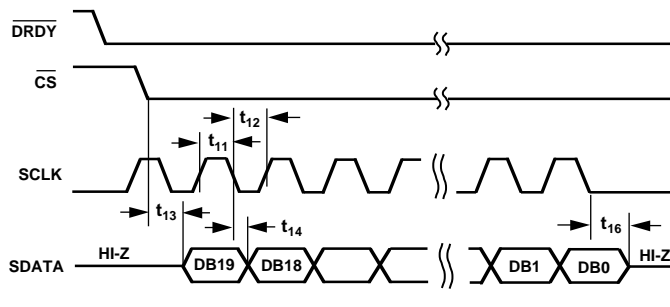

Figure 5b. SEC Mode Timing Diagram

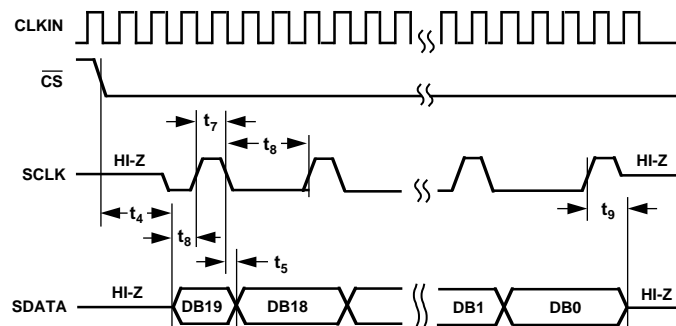

Figure 6. SSC Mode Timing Diagram

TERMINOLOGY

LINEARITY ERROR

This is the maximum deviation of any code from a straight line passing through the endpoints of the transfer function. The endpoints of the transfer function are zero-scale (not to be confused with bipolar zero), a point 0.5 LSB below the first code transition (000 . . . 000 to 000 . . . 001) and full scale, a point 1.5 LSB above the last code transition (111 . . . 110 to 111 . . . 111). The error is expressed as a percentage of full scale.

DIFFERENTIAL LINEARITY ERROR

This is the difference between any code's actual width and the ideal (1 LSB) width. Differential linearity error is expressed in LSBs. A differential linearity specification of ± 1 LSB or less guarantees monotonicity.

POSITIVE FULL-SCALE ERROR

Positive full-scale error is the deviation of the last code transition (111 . . . 110 to 111 . . . 111) from the ideal ($V_{REF} - 3/2$ LSBs). It applies to both positive and negative analog input ranges.

UNIPOLAR OFFSET ERROR

Unipolar offset error is the deviation of the first code transition from the ideal ($AGND + 0.5$ LSB) when operating in the unipolar mode.

BIPOLAR ZERO ERROR

This is the deviation of the midscale transition (0111 . . . 111 to 1000 . . . 000) from the ideal ($AGND - 0.5$ LSB) when operating in the bipolar mode.

BIPOLAR NEGATIVE FULL-SCALE ERROR

This is the deviation of the first code transition from the ideal ($-V_{REF} + 0.5$ LSB), when operating in the bipolar mode.

POSITIVE FULL-SCALE OVERRANGE

Positive full-scale overrange is the amount of overhead available to handle input voltages greater than $+V_{REF}$ (for example, noise peaks or excess voltages due to system gain errors in system calibration routines) without introducing errors due to overloading the analog modulator or overflowing the digital filter.

NEGATIVE FULL-SCALE OVERRANGE

This is the amount of overhead available to handle voltages below $-V_{REF}$ without overloading the analog modulator or overflowing the digital filter. Note that the analog input will accept negative voltage peaks even in the unipolar mode.

OFFSET CALIBRATION RANGE

In the system calibration modes (SC2 Low) the AD7703 calibrates its offset with respect to the A_{IN} pin. The offset calibration range specification defines the range of voltages that the AD7703 can accept and still calibrate offset accurately.

FULL-SCALE CALIBRATION RANGE

This is the range of voltages that the AD7703 can accept in the system calibration mode and still calibrate full scale correctly.

INPUT SPAN

In system calibration schemes, two voltages applied in sequence to the AD7703's analog input define the analog input range. The input span specification defines the minimum and maximum input voltages from zero to full scale that the AD7703 can accept and still calibrate gain accurately.

AD7703

PIN FUNCTION DESCRIPTION

Pin	Mnemonic	Description
1	MODE	Selects the Serial Interface Mode. If MODE is tied to DGND, the Synchronous External Clocking (SEC) mode is selected. SCLK is configured as an input, and the output appears without formatting, the MSB coming first. If MODE is tied to +5 V, the AD7703 operates in the Synchronous Self-Clocking (SSC) mode. SCLK is configured as an output, with a clock frequency for $f_{CLKIN}/4$ and 25% duty cycle.
2	CLKOUT	Clock Output to generate an Internal Master Clock by connecting a crystal between CLKOUT and CLKIN. If an external clock is used, CLKOUT is not connected.
3	CLKIN	Clock Input for External Clock.
4, 17	SC1, SC2	System Calibration Pins. The state of these pins, when CAL is taken high, determines the type of calibration performed.
5	DGND	Digital Ground. Ground reference for all digital signals.
6	DV _{SS}	Digital Negative Supply, -5 V nominal.
7	AV _{SS}	Analog Negative Supply, -5 V nominal.
8	AGND	Analog Ground. Ground reference for all analog signals.
9	A _{IN}	Analog Input.
10	V _{REF}	Voltage Reference Input, +2.5 V nominal. This determines the value of positive full-scale in the unipolar mode and of both positive and negative full-scale in the Bipolar Mode.
11	\overline{SLEEP}	Sleep mode pin. When this pin is taken low, the AD7703 goes into a low-power mode with typically 10 μ W power consumption.
12	BP/ \overline{UP}	Bipolar/Unipolar mode pin. When this pin is Low, the AD7703 is configured for a unipolar input range going from AGND to V _{REF} . When Pin 12 is High, the AD7703 is configured for a bipolar input range, $\pm V_{REF}$.
13	CAL	Calibration mode pin. When CAL is taken High for more than 4 cycles, the AD7703 is reset and performs a calibration cycle when CAL is brought Low again. The CAL pin can also be used as a strobe to synchronize the operation of several AD7703s.
14	AV _{DD}	Analog Positive Supply, +5 V nominal.
15	DV _{DD}	Digital Positive Supply, +5 V nominal.
16	\overline{CS}	Chip Select Input. When \overline{CS} is brought low, the AD7703 will begin to transmit serial data in a format determined by the state of the MODE pin.
18	\overline{DRDY}	Data Ready Output. \overline{DRDY} is low when valid data is available in the output register. It goes high after transmission of a word is completed. It also goes high for four clock cycles when a new data word is being loaded into the output register, to indicate that valid data is not available, irrespective of whether data transmission is complete or not.
19	SCLK	Serial Clock Input/Output. The SCLK pin is configured as an input or output, dependent on the type of serial data transmission that has been selected by the MODE pin. When configured as an output in the Synchronous Self-Clocking mode, it has a frequency of $f_{CLKIN}/4$ and a duty cycle of 25%.
20	SDATA	Serial Data Output. The AD7703's output data is available at this pin as a 20-bit serial word.

Table I. Bit Weight Table (2.5 V Reference Voltage)

μ V	UNIPOLAR MODE			BIPOLAR MODE		
	LSBs	% FS	ppm FS	LSBs	% FS	ppm FS
0.596	0.25	0.0000238	0.24	0.13	0.0000119	0.12
1.192	0.5	0.0000477	0.48	0.26	0.0000238	0.24
2.384	1.00	0.0000954	0.95	0.5	0.0000477	0.48
4.768	2.00	0.0001907	1.91	1.00	0.0000954	0.95
9.537	4.00	0.0003814	3.81	2.00	0.0001907	1.91

PIN CONFIGURATION DIP, Cerdip, SOIC

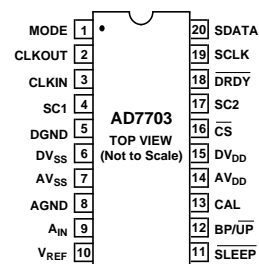

GENERAL DESCRIPTION

The AD7703 is a 20-bit A/D converter with on-chip digital filtering, intended for the measurement of wide dynamic range, low frequency signals such as those representing chemical, physical or biological processes. It contains a charge-balancing (sigma-delta) ADC, calibration microcontroller with on-chip static RAM, a clock oscillator and a serial communications port.

The analog input signal to the AD7703 is continuously sampled at a rate determined by the frequency of the master clock, CLKIN. A charge-balancing A/D converter (sigma-delta modulator) converts the sampled signal into a digital pulse train whose duty cycle contains the digital information. A six-pole Gaussian digital low-pass filter processes the output of the sigma-delta modulator and updates the 20-bit output register at a 4 kHz rate. The output data can be read from the serial port randomly or periodically at any rate up to 4 kHz.

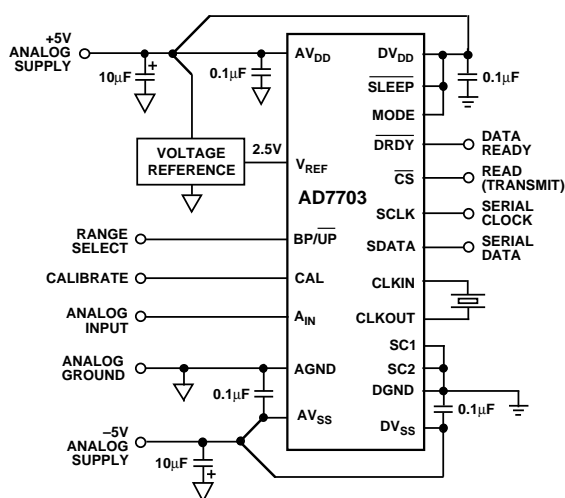

Figure 7. Typical System Connection Diagram

The AD7703 can perform self-calibration using the on-chip calibration microcontroller and SRAM to store calibration parameters. A calibration cycle may be initiated at any time using the CAL control input.

Other system components may also be included in the calibration loop to remove offset and gain errors in the input channel.

For battery operation, the AD7703 also offers a standby mode that reduces idle power consumption to typically 10 µW.

THEORY OF OPERATION

The general block diagram of a sigma-delta ADC is shown in Figure 8. It contains the following elements:

1. A sample-and-hold amplifier
2. A differential amplifier or subtracter
3. An analog low-pass filter
4. A 1-bit A/D converter (comparator)
5. A 1-bit DAC
6. A digital low-pass filter

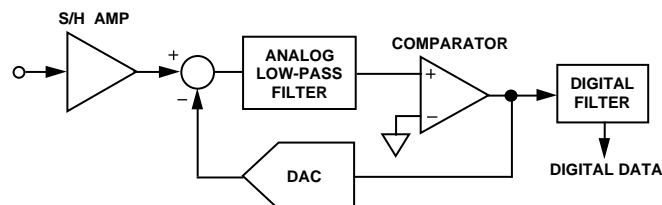

Figure 8. General Sigma-Delta ADC

In operation, the sampled analog signal is fed to the subtracter, along with the output of the 1-bit DAC. The filtered difference signal is fed to the comparator, whose output samples the difference signal at a frequency many times that of the analog signal frequency (oversampling).

Oversampling is fundamental to the operation of sigma-delta ADCs. Using the quantization noise formula for an ADC:

$$SNR = (6.02 \times \text{number of bits} + 1.76) \text{ dB},$$

a 1-bit ADC or comparator yields an SNR of 7.78 dB.

The AD7703 samples the input signal at 16 kHz, which spreads the quantization noise from 0 kHz to 8 kHz. Since the specified analog input bandwidth of the AD7703 is only 0 Hz to 10 Hz, the noise energy in this bandwidth would be only 1/800 of the total quantization noise, assuming that the noise energy was spread evenly throughout the spectrum. It is reduced still further by analog filtering in the modulator loop, which shapes the quantization noise spectrum to move most of the noise energy to frequencies above 10 Hz. The SNR performance in the 0 Hz to 10 Hz range is conditioned to the 20-bit level in this fashion.

The output of the comparator provides the digital input for the 1-bit DAC, so the system functions as a negative feedback loop which minimizes the difference signal. The digital data that represents the analog input voltage is in the duty cycle of the pulse train appearing at the output of the comparator. It can be retrieved as a parallel binary data word using a digital filter.

Sigma-delta ADCs are generally described by the order of the analog low-pass filter. A simple example of a first order sigma-delta ADC is shown in Figure 8. This contains only a first-order low-pass filter or integrator.

The AD7703 uses a second-order sigma-delta modulator and a digital filter that provides a rolling average of the sampled output. After power-up or if there is a step change in the input voltage, there is a settling time before valid data is obtained.

AD7703

DIGITAL FILTERING

The AD7703's digital filter behaves like an analog filter, with a few minor differences.

First, since digital filtering occurs after the A to D conversion process, it can remove noise injected during the conversion process. Analog filtering cannot do this.

On the other hand, analog filtering can remove noise superimposed on the analog signal before it reaches the ADC. Digital filtering cannot do this and noise peaks riding on signals near full scale have the potential to saturate the analog modulator and digital filter, even though the average value of the signal is within limits. To alleviate this problem, the AD7703 has overrange headroom built into the sigma-delta modulator and digital filter which allows overrange excursions of 100 mV. If noise signals are larger than this, consideration should be given to analog input filtering, or to reducing the gain in the input channel so that a full-scale input (2.5 V) gives only a half-scale input to the AD7703 (1.25 V). This will provide an overrange capability greater than 100% at the expense of reducing the dynamic range by 1 bit (50%).

FILTER CHARACTERISTICS

The cutoff frequency of the digital filter is $f_{CLK}/409600$. At the maximum clock frequency of 4.096 MHz, the cutoff frequency of the filter is 10 Hz and the data update rate is 4 kHz.

Figure 9 shows the filter frequency response. This is a 6-pole Gaussian response that provides 55 dB of 60 Hz rejection for a 10 Hz cutoff frequency. If the clock frequency is halved to give a 5 Hz cutoff, 60 Hz rejection is better than 90 dB.

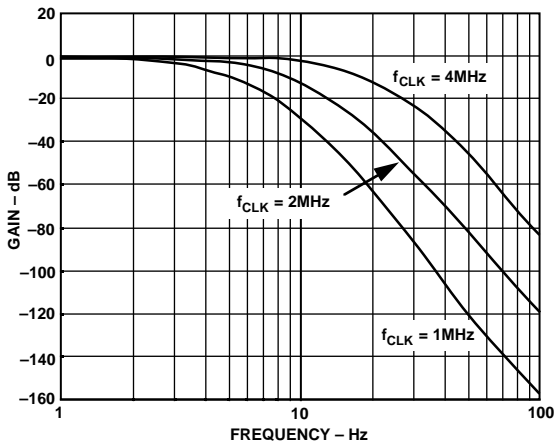

Figure 9. Frequency Response of AD7703 Filter

Since the AD7703 contains this low-pass filtering, there is a settling time associated with step function inputs, and data will be invalid after a step change until the settling time has elapsed. The AD7703 is, therefore, unsuitable for high speed multiplexing, where channels are switched and converted sequentially at high rates, as switching between channels can cause a step change in the input. However, slow multiplexing of the AD7703 is possible, provided that the settling time is allowed to elapse before data for the new channel is accessed.

The output settling of the AD7703 in response to a step input change is shown in Figure 10. The Gaussian response has fast settling with no overshoot, and the worst-case settling time to $\pm 0.0007\%$ is 125 ms with a 4.096 MHz master clock frequency.

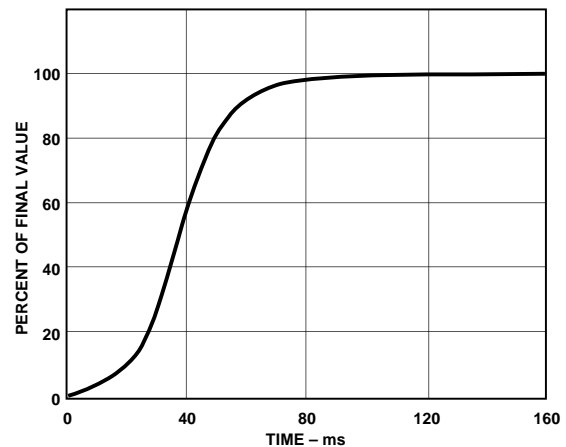

Figure 10. AD7703 Step Response

USING THE AD7703

SYSTEM DESIGN CONSIDERATIONS

The AD7703 operates differently from successive approximation ADCs or integrating ADCs. Since it samples the signal continuously, like a tracking ADC, there is no need for a start convert command. The 20-bit output register is updated at a 4 kHz rate, and the output can be read at any time, either synchronously or asynchronously.

CLOCKING

The AD7703 requires a master clock input, which may be an external TTL/CMOS compatible clock signal applied to the CLKIN pin (CLKOUT not used). Alternatively, a crystal of the correct frequency can be connected between CLKIN and CLKOUT, when the clock circuit will function as a crystal controlled oscillator.

Figure 11 shows a simple model of the on-chip gate oscillator and Table II gives some typical capacitor values to be used with various resonators.

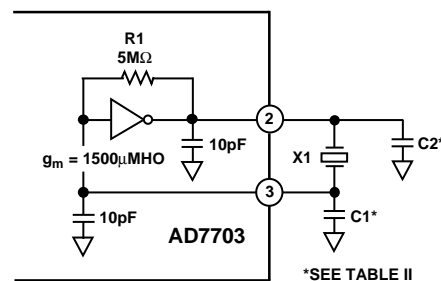

Figure 11. On-Chip Gate Oscillator

Table II. Resonator Loading Capacitors

Resonators	C1	C2
Ceramic		
200 kHz	330 pF	470 pF
455 kHz	100 pF	100 pF
1.0 MHz	50 pF	50 pF
2.0 MHz	20 pF	20 pF
Crystals		
2.000 MHz	30 pF	30 pF
3.579 MHz	20 pF	20 pF
4.096 MHz	None	None

The input sampling frequency, output data rate, filter characteristics and calibration time are all directly related to the master clock frequency f_{CLKIN} by the ratios given in the specification table under Dynamic Performance. Therefore, the first step in system design with the AD7703 is to select a master clock frequency suitable for the bandwidth and output data rate required by the application.

ANALOG INPUT RANGES

The AD7703 performs conversion relative to an externally supplied reference voltage, which allows easy interfacing to ratio-metric systems. In addition, either unipolar or bipolar input voltage ranges may be selected using the BP/UP input. With BP/UP tied low, the input range is unipolar and the span is $(V_{REF} - V_{AGND})$, where V_{AGND} is the voltage at the device AGND pin. With BP/UP tied high, the input range is bipolar and the span is $2 V_{REF}$. In the bipolar mode both positive and negative full scale are directly determined by V_{REF} . This offers superior tracking of positive and negative full scale and better midscale (bipolar zero) stability than bipolar schemes that simply scale and offset the input range.

The digital output coding for the unipolar range is unipolar binary and for the bipolar range it is offset binary. Bit weights for the unipolar and bipolar modes are shown in Table I.

ACCURACY

Sigma-delta ADCs, like VFCs and other integrating ADCs, do not contain any source of nonmonotonicity and inherently offer no missing codes performance.

The AD7703 achieves excellent linearity by the use of high quality, on-chip silicon dioxide capacitors, which have a very

low capacitance/voltage coefficient. The device also achieves low input drift through the use of chopper-stabilized techniques in its input stage. To ensure excellent performance over time and temperature, the AD7703 uses digital calibration techniques which minimize offset and gain error to typically ± 4 LSBs.

AUTOCALIBRATION

The AD7703 offers both self-calibration and system-calibration facilities. For calibration to occur, the on-chip microcontroller must record the modulator output for two different input conditions. These are the “zero scale” and “full scale” points. In unipolar self-calibration mode, the zero scale point is V_{AGND} and the full-scale point is V_{REF} . With these readings the microcontroller can calculate the gain slope for the input to output transfer function of the converter. In unipolar mode the slope factor is determined by dividing the span between zero and full scale by 2^{20} . In bipolar mode it is determined by dividing the span by 2^{19} since the inputs applied represent only half the total codes. In both unipolar and bipolar modes the slope factor is saved and used to calculate the binary output code when an analog input is applied to the device. Table IV gives the output code size after calibration.

System calibration allows the AD7703 to compensate for system gain and offset errors. A typical circuit where this might be used is shown in Figure 12.

System calibration performs the same slope factor calculations as self-calibration but uses voltage values presented by the system to the A_{IN} pin for the zero and full-scale points. There are two system calibration modes.

The first mode offers system level calibration for system offset and system gain. This is a two step operation. The zero-scale point must be presented to the converter first. It must be applied to the converter before the calibration step is initiated and remain stable until the step is complete. The DRDY output from the device will signal when the step is complete by going low. After the zero-scale point is calibrated the full-scale point is applied and the second calibration step is initiated. Again the voltage must remain stable throughout the calibration step.

The two step calibration mode offers another feature. After the sequence has been completed, additional offset calibrations can be performed by themselves to adjust the zero reference point to a new system zero reference value. This second system calibration mode uses an input voltage for the zero-scale calibration point but uses the V_{REF} value for the full-scale point.

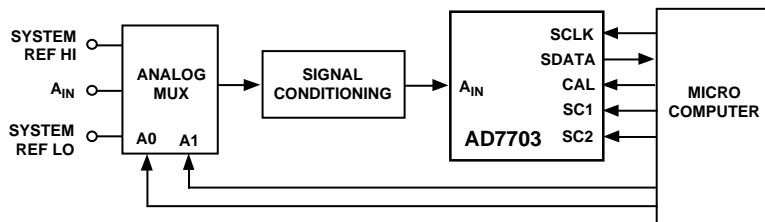

Figure 12. Typical Connections for System Calibration

AD7703

Initiating Calibration

Table III illustrates the calibration modes available in the AD7703. Not shown in the table is the function of the $\overline{\text{BP/UP}}$ pin which determines whether the converter has been calibrated to measure bipolar or unipolar signals. A calibration step is initiated by bringing the CAL pin high for at least 4 CLKIN cycles and then bringing it low again. The states of SC1 and SC2 along with the $\overline{\text{BP/UP}}$ pin will determine the type of calibration to be performed. All three signals should be stable before the CAL pin is taken positive. The SC1 and SC2 inputs are latched when CAL goes high. The $\overline{\text{BP/UP}}$ input is not latched and therefore must remain in a fixed state throughout the calibration and measurement cycles. Any time the state of the $\overline{\text{BP/UP}}$ is changed, a new calibration cycle must be performed to enable the AD7703 to function properly in the new mode.

When a calibration step is initiated, the $\overline{\text{DRDY}}$ signal will go high and remain high until the step is finished. Table III shows the number of clock cycles each calibration requires. Once a calibration step is initiated it must finish before a new calibration step can be executed. In the two step system calibration mode, the offset calibration step must be initiated before initiating the gain calibration step.

When self-calibration is completed, $\overline{\text{DRDY}}$ falls and the output port is updated with a data word that represents the analog input signal. When a system calibration step is completed, $\overline{\text{DRDY}}$ will fall and the output port will be updated with the appropriate data value (all 0s for the zero-scale point and all 1s for the full-scale point). In the system calibration mode, the digital filter must settle before the output code will represent the value of the analog input signal. Tables IV and V indicate the output code size and output coding of the AD7703 in its various modes. In these tables, S_{OFF} is the measured system offset in volts and S_{GAIN} is the measured system gain at the full-scale point in volts.





Span and Offset Limits

Whenever a system calibration mode is used, there are limits on the amount of offset and span which can be accommodated.

The range of input span in both the unipolar and bipolar modes has a minimum value of $0.8 V_{\text{REF}}$ and a maximum value of $2 (V_{\text{REF}} + 0.1 \text{ V})$.

The amount of offset which can be accommodated depends on whether the unipolar or bipolar mode is being used. In unipolar mode, the system calibration modes can handle a maximum offset of $0.2 V_{\text{REF}}$ and a minimum offset of $-(V_{\text{REF}} + 0.1 \text{ V})$. Thus the AD7703 in the unipolar mode can be calibrated to mimic bipolar operation.

Table III. Calibration Truth Table

CAL	SC1	SC2	CAL TYPE	ZERO-SCALE CAL	FULL-SCALE CAL	SEQUENCE	CALIBRATION TIME
	0	0	Self-Cal	V_{AGND}	V_{REF}	One Step	3,145,655 Clock Cycles
	1	1	System Offset	A_{IN}	–	1st Step	1,052,599 Clock Cycles
	0	1	System Gain	–	\overline{A}_{IN}	2nd Step	1,068,813 Clock Cycles
	1	0	System Offset	\overline{A}_{IN}	V_{REF}	One Step	2,117,389 Clock Cycles

NOTE

$\overline{\text{DRDY}}$ remains high throughout the calibration sequence. In the Self-Cal mode, $\overline{\text{DRDY}}$ falls once the AD7703 has settled to the analog input. In all other modes $\overline{\text{DRDY}}$ falls as the device begins to settle.

Table IV. Output Code Size After Calibration

CAL MODE	ZERO-SCALE	GAIN FACTOR	1 LSB	
			UNIPOLAR	BIPOLAR
Self-Cal	V_{AGND}	V_{REF}	$\frac{(V_{\text{REF}} - V_{\text{AGND}})}{1048576}$	$\frac{2(V_{\text{REF}} - V_{\text{AGND}})}{1048576}$
System Cal	S_{OFF}	S_{GAIN}	$\frac{(S_{\text{GAIN}} - S_{\text{OFF}})}{1048576}$	$\frac{2(S_{\text{GAIN}} - S_{\text{OFF}})}{1048576}$

Table V. AD7703 Output Coding

INPUT VOLTAGE, UNIPOLAR MODE			INPUT VOLTAGE, BIPOLAR MODE	
System Cal	Self Cal	Output Codes	Self-Cal	System Cal
$>(S_{GAIN} - 1.5 \text{ LSB})$	$>(V_{REF} - 1.5 \text{ LSB})$	FFFFF	$>(V_{REF} - 1.5 \text{ LSB})$	$>(S_{GAIN} - 1.5 \text{ LSB})$
$S_{GAIN} - 1.5 \text{ LSB}$	$V_{REF} - 1.5 \text{ LSB}$	$\frac{\text{FFFFF}}{\text{FFFFE}}$	$V_{REF} - 1.5 \text{ LSB}$	$S_{GAIN} - 1.5 \text{ LSB}$
$(S_{GAIN} - S_{OFF})/2 - 0.5 \text{ LSB}$	$(V_{REF} - V_{AGND})/2 - 0.5 \text{ LSB}$	$\frac{80000}{7FFFF}$	$V_{AGND} - 0.5 \text{ LSB}$	$S_{OFF} - 0.5 \text{ LSB}$
$S_{OFF} + 0.5 \text{ LSB}$	$V_{AGND} + 0.5 \text{ LSB}$	$\frac{00001}{00000}$	$-V_{REF} + 0.5 \text{ LSB}$	$-S_{GAIN} + 2 S_{OFF} + 0.5 \text{ LSB}$
$<(S_{OFF} + 0.5 \text{ LSB})$	$<(V_{AGND} + 0.5 \text{ LSB})$	00000	$<(-V_{REF} + 0.5 \text{ LSB})$	$<(-S_{GAIN} + 2 S_{OFF} + 0.5 \text{ LSB})$

In the bipolar mode the system offset calibration range is restricted to $\pm 0.4 V_{REF}$. It should be noted that the span restrictions limit the amount of offset which can be calibrated. The span range of the converter in bipolar mode is equidistant around the voltage used for the zero scale point. When the zero-scale point is calibrated it must not cause either of the two endpoints of the bipolar transfer function to exceed the positive or the negative input overrange points ($+V_{REF} + 0.1 \text{ V}$ or $-V_{REF} + 0.1 \text{ V}$). If the span range is set to a minimum ($0.8 V_{REF}$) the offset voltage can move $+0.4 V_{REF}$ without causing the end points of the transfer function to exceed the overrange points. Alternatively, if the span range is set to $2 V_{REF}$, the input offset cannot move more than $+0.1 \text{ V}$ or -0.1 V before an endpoint of the transfer function exceeds the input overrange limit.

POWER-UP AND CALIBRATION

A calibration cycle must be carried out after power-up to initialize the device to a consistent starting condition and correct calibration. The CAL pin must be held high for at least four clock cycles, after which calibration is initiated on the falling edge of CAL and takes a maximum of 3,145,655 clock cycles (approximately 768 ms with a 4.096 MHz clock). See Table III.

The type of calibration cycle initiated by CAL is determined by the SC1 and SC2 inputs, in accordance with Table III.

Drift Considerations

The AD7703 uses chopper stabilization techniques to minimize input offset drift. Charge injection in the analog switches and leakage currents at the sampling node are the primary sources of offset voltage drift in the converter. Figure 13 indicates the typical offset due to temperature changes after calibration at 25°C . Drift is relatively flat up to 75°C . Above this temperature, leakage current becomes the main source of offset drift. Since leakage current doubles approximately every 10°C , the offset drifts accordingly. The value of the voltage on the sample capacitor is

updated at a rate determined by the master clock, therefore the amount of offset drift which occurs will be proportional to the elapsed time between samples. Thus, to minimize offset drift at higher temperatures, higher CLKIN rates are recommended.

Gain drift within the converter depends mainly upon the temperature tracking of the internal capacitors. It is not affected by leakage currents so that it is significantly less than offset drift. The typical gain drift of the AD7703 is less than 40 LSBs over the specified temperature range.

Measurement errors due to offset drift or gain drift can be eliminated at any time by recalibrating the converter. Using the system calibration mode can also minimize offset and gain errors in the signal conditioning circuitry. Integral and differential linearity are not significantly affected by temperature changes.

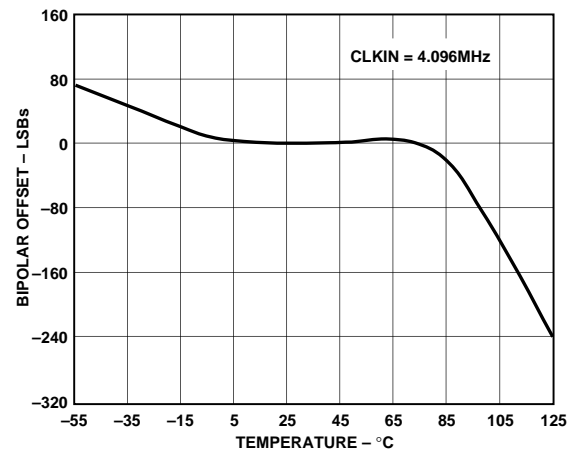

Figure 13. Typical Bipolar Offset vs. Temperature after Calibration at $+25^\circ\text{C}$

AD7703

INPUT SIGNAL CONDITIONING

Reference voltages from +1 V to +3 V may be used with the AD7703, with little degradation in performance. Input ranges that cannot be accommodated by this range of reference voltages may be achieved by input signal conditioning. This may take the form of gain to accommodate a smaller signal range, or passive attenuation to reduce a larger input voltage range.

Source Resistance

If passive attenuators are used in front of the AD7703, care must be taken to ensure that the source impedance is sufficiently low. The dc input resistance for the AD7703 is over 1 GΩ. In parallel with this there is a small dynamic load which varies with the clock frequency (see Figure 14). Each time the

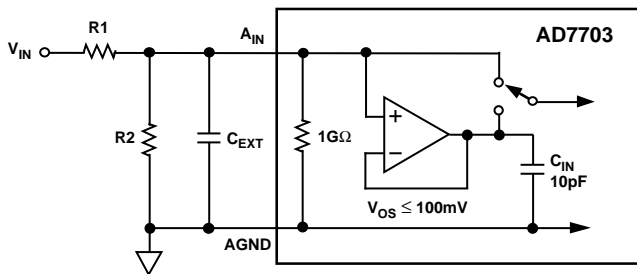

Figure 14. Equivalent Input Circuit and Input Attenuator

analog input is sampled, a 10 pF capacitor draws a charge packet of maximum 1 pC ($10 \text{ pF} \times 100 \text{ mV}$) from the analog source with a frequency $f_{CLKIN}/256$. For a 4.096 MHz CLKIN, this yields an average current draw of 16 nA. After each sample the AD7703 allows 62 clock periods for the input voltage to settle. The equation which defines settling time is:

$$V_O = V_{IN} [1 - e^{-t/RC}]$$

where V_O is the final settled value, V_{IN} is the value of the input signal, R is the value of the input source resistance, C is the 10 pF sample capacitor. The value of t is equal to $62/f_{CLKIN}$. The following equation can be developed which gives the maximum allowable source resistance, $R_{S(MAX)}$ for an error of V_E .

$$R_{S(MAX)} = \frac{62}{f_{CLKIN} \cdot (10 \text{ pF}) \cdot \ln(100 \text{ mV} / V_E)}$$

Provided the source resistance is less than this value, the analog input will settle within the desired error band in the requisite 62 clock periods. Insufficient settling leads to offset errors. These can be calibrated in system calibration schemes.

If a limit of 600 nV (0.25 LSB at 20 bits) is set for the maximum offset voltage, then the maximum allowable source resistance is 125 kΩ from the above equation, assuming that there is no external stray capacitance.

An RC filter may be added in front of the AD7703 to reduce high frequency noise. With an external capacitor added from AIN to AGND, the following equation will specify the maximum allowable source resistance:

$$R_{S(MAX)} = \frac{62}{f_{CLKIN} \cdot (C_{IN} + C_{EXT}) \cdot \ln \left[\frac{100 \text{ mV} \cdot \frac{C_{IN}}{(C_{IN} + C_{EXT})}}{V_E} \right]}$$

The practical limit to the maximum value of source resistance is thermal (Johnson) noise. A practical resistor may be modeled as an ideal (noiseless) resistor in series with a noise voltage source or in parallel with a noise current source.

$$V_n = \sqrt{4 kTRf} \text{ Volts}$$

$$i_n = \sqrt{4 kTf/R} \text{ Amperes}$$

where k is Boltzmann's constant ($1.38 \times 10^{-23} \text{ J/K}$), and T is temperature in degrees Kelvin ($^{\circ}\text{C} + 273$).

Active signal conditioning circuits such as op amps generally do not suffer from problems of high source impedance. Their open loop output resistance is normally only tens of ohms and, in any case, most modern general purpose op amps have sufficiently fast closed loop settling time for this not to be a problem. Offset voltage in op amps can be eliminated in a system calibration routine.

Antialias Considerations

The digital filter of the AD7703 does not provide any rejection at integer multiples of the sampling frequency ($n f_{CLKIN}/256$, where $n = 1, 2, 3 \dots$).

With a 4.096 MHz master clock there are narrow ($\pm 10 \text{ Hz}$) bands at 16 kHz, 32 kHz, 48 kHz, etc., where noise passes unattenuated to the output.

However, due to the AD7703's high oversampling ratio of 800 (16 kHz to 20 Hz) these bands occupy only a small fraction of the spectrum, and most broadband noise is filtered.

The reduction in broadband noise is given by:

$$e_{out} = e_{in} \sqrt{2 f_C / f_S} = 0.035 e_{in}$$

where e_{in} and e_{out} are rms noise terms referred to the input and f_C is the filter -3 dB corner frequency ($f_{CLKIN}/409600$) and f_S is the sampling frequency ($f_{CLKIN}/256$).

Since the ratio of f_S to f_{CLKIN} is fixed, the digital filter reduces broadband white noise by 96.5% independent of the master clock frequency.

VOLTAGE REFERENCE CONNECTIONS

The voltage applied to the V_{REF} pin defines the analog input range. The specified reference voltage is 2.5 V, but the AD7703 will operate with reference voltages from 1 V to 3 V with little degradation in performance.

The reference input presents exactly the same dynamic load as the analog input, but in the case of the reference input, source resistance and long settling time introduce gain errors rather than offset errors. Fortunately, most precision references have sufficiently low output impedance and wide enough bandwidth to settle to the required accuracy within 62 clock cycles.

The digital filter of the AD7703 removes noise from the reference input, just as it does with noise at the analog input, and the same limitations apply regarding lack of noise rejection at integer multiples of the sampling frequency. Note that the reference should be chosen to minimize noise below 10 Hz. The AD7703 typically exhibits 1.6 LSB rms noise in its measurements. This specification assumes a clean reference. Many monolithic bandgap references are available which can supply the 2.5 V needed for the AD7703. However, some of these are not specified for noise especially in the 0.1 Hz to 10 Hz bandwidth. If the reference noise in this bandwidth is excessive, it can degrade the performance of the AD7703. Recommended references are the AD580 and the LT1019. Both of these 2.5 V references typically have less than 10 μ V p-p noise in the 0.1 Hz to 10 Hz band.

POWER SUPPLIES AND GROUNDING

AGND is the ground reference voltage for the AD7703, and is completely independent of DGND. Any noise riding on the AGND input with respect to the system analog ground will cause conversion errors. AGND should therefore be used as the system ground and also as the ground for the analog input and the reference voltage.

The analog and digital power supplies to the AD7703 are independent and separately pinned out, to minimize coupling between analog and digital sections of the device. The digital filter will provide rejection of broadband noise on the power supplies, except at integer multiples of the sampling frequency.

Therefore, the two analog supplies should be individually decoupled to AGND using 100 nF ceramic capacitors to provide power supply noise rejection at these frequencies. The two digital supplies should similarly be decoupled to DGND.

The positive digital supply (DV_{DD}) must never exceed the positive analog supply (AV_{DD}) by more than 0.3 V. Power supply sequencing is therefore important. If separate analog and digital supplies are used, care must be taken to ensure that the analog supply is powered up first.

It is also important that power is applied to the AD7703 before signals at V_{REF} , A_{IN} or the logic input pins in order to avoid any possibility of latch-up. If separate supplies are used for the AD7703 and the system digital circuitry, then the AD7703 should be powered up first.

A typical scheme for powering the AD7703 from a single set of ± 5 V rails is shown Figure 7. In this circuit AV_{DD} and DV_{DD} are brought along separate tracks from the same +5 V supply. Thus, there is no possibility of the digital supply coming up before the analog supply.

SLEEP MODE

The low power standby mode is initiated by taking the \overline{SLEEP} input low, which shuts down all analog and digital circuits and reduces power consumption to 10 μ W. When coming out of SLEEP mode it is sometimes possible (when using a crystal to generate CLKIN, for example) to lose the calibration coefficients. Therefore, it is advisable as a safeguard to always do a calibration cycle after coming out of SLEEP mode.

DIGITAL INTERFACE

The AD7703's serial communications port allows easy interfacing to industry standard microprocessors. Two different modes of operation are available, optimized for different types of interface.

AD7703

SYNCHRONOUS SELF-CLOCKING MODE (SSC)

The SSC mode (MODE pin high) allows easy interfacing to serial-parallel conversion circuits in systems with parallel data communication. This mode allows interfacing to 74XX299 Universal Shift registers without any additional decoding. The SSC mode can also be used with microprocessors such as the 68HC11 and 68HC05, which allow an external device to clock their serial port.

Figure 15 shows the timing diagram for the SSC mode. Data is clocked out by an internally generated serial clock. The AD7703 divides each sampling interval into sixteen distinct periods. Eight periods of 64 clock pulses are for analog settling and eight periods of 64 clock pulses are for digital computation. The status of CS is polled at the beginning of each digital computation period. If it is low at any of these times, then

SCLK will become active and the data word currently in the output register will be transmitted, MSB first. After the LSB has been transmitted DRDY will go high until the new data word becomes available. If CS, having been brought low, is taken high again at any time during data transmission, SDATA and SCLK will go three-state after the current bit finishes. If CS is subsequently brought low, transmission will resume with the next bit during the subsequent digital computation period. If transmission has not been initiated and completed by the time the next data word is available, DRDY will go high for four clock cycles then low again as the new word is loaded into the output register.

A more detailed diagram of the data transmission in the SSC mode is shown in Figure 16. Data bits change on the falling edge of SCLK and are valid on the rising edge of SCLK.

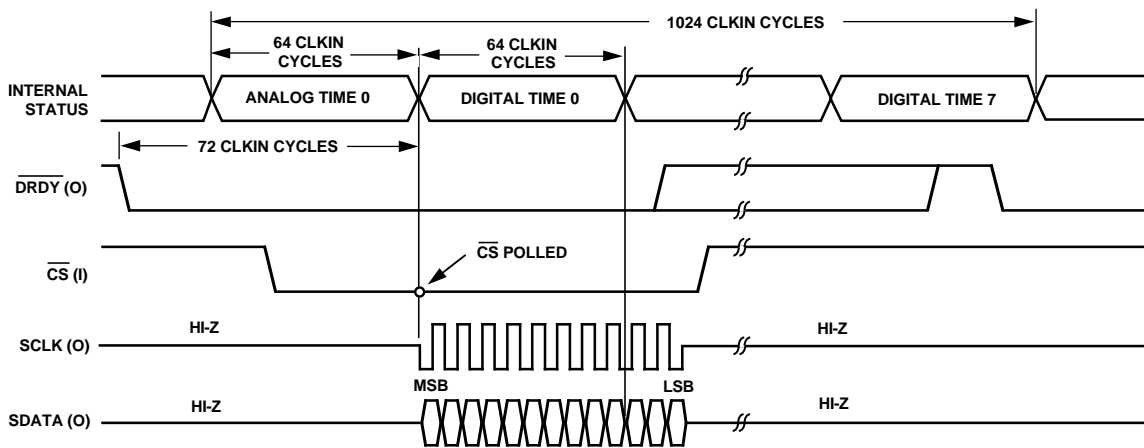

Figure 15. Timing Diagram for SSC Data Transmission Mode

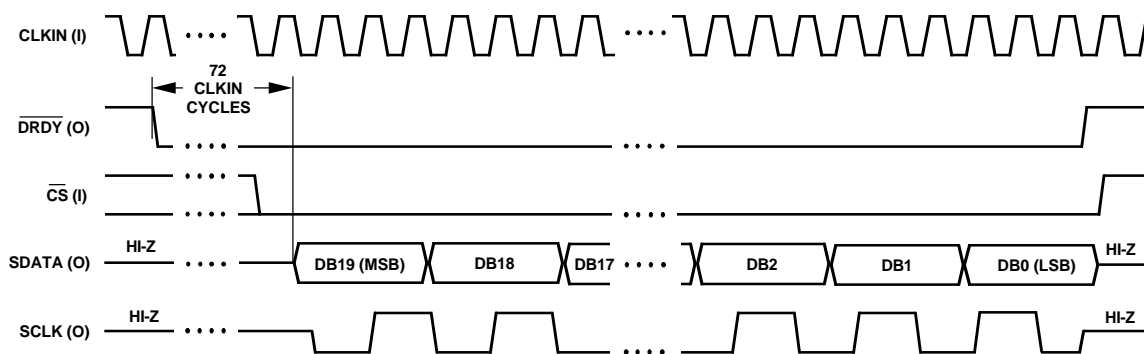

Figure 16. SSC Mode Showing Data Timing Relative to SCLK

SYNCHRONOUS EXTERNAL CLOCK MODE (SEC)

The SEC mode (MODE pin grounded) is designed for direct interface to the synchronous serial ports of industry standard microprocessors such as the 68HC11 and 68HC05. The SEC mode also allows customized interfaces, using I/O port pins, to microprocessors that do not have a direct fit with the AD7703's other mode.

As shown in Figure 17, a falling edge on \overline{CS} enables the serial data output with the MSB initially valid. Subsequent data bits change on the falling edge of an externally supplied SCLK. After the LSB has been transmitted, \overline{DRDY} and SDATA go three-state. If \overline{CS} is low and the AD7703 is still transmitting data when a new data word becomes available, the old data word continues to be transmitted and the new data is lost.

If \overline{CS} is taken high at any time during data transmission, SDATA will go three-state immediately. If \overline{CS} returns low, the AD7703 will continue transmission with the same data bit. If transmission has not been initiated and completed by the time the next data word becomes available, and if \overline{CS} is high, \overline{DRDY} will return high for four clock cycles, then fall as the new word is loaded into the output register.

DIGITAL NOISE AND OUTPUT LOADING

As mentioned earlier, the AD7703 divides its internal timing into two distinct phases, analog sampling and settling and digital computation. In the SSC mode, data is transmitted only during the digital computation periods, to minimize the effects of digital noise on analog performance. In the SEC mode data transmission is externally controlled, so this automatic safeguard does not exist. To compensate, the AD7703 should be synchronized to the digital system clock via CLKIN when used in the SEC mode.

Whatever mode of operation is used, resistive and capacitive loads on digital outputs should be minimized in order to reduce crosstalk between analog and digital portions of the circuit. For this reason connection to low-power CMOS logic such as one of the 4000 series or 74C families is recommended.

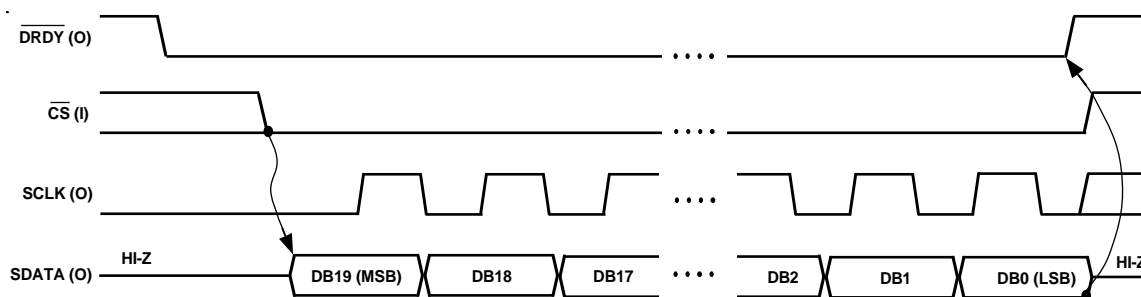
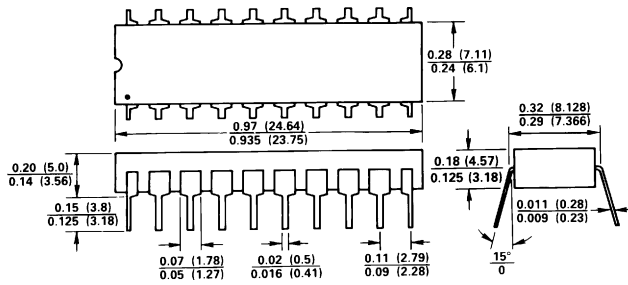

Figure 17. Timing Diagram for the SEC Mode

MECHANICAL INFORMATION

Dimensions shown in inches and (mm)

20-Pin Plastic DIP (Suffix N)



20-Pin Cerdip (Suffix Q)

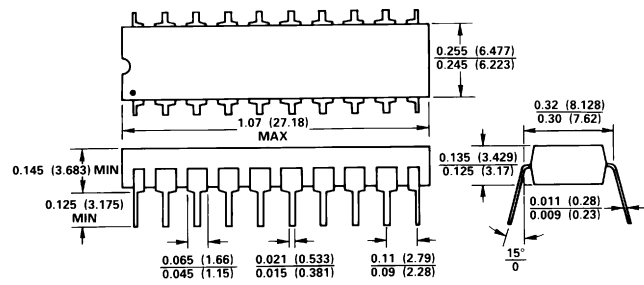

20-Lead SOIC (Suffix R)

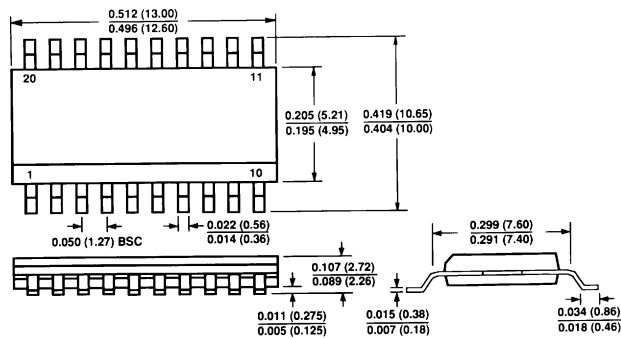

C1477b-2-9/96

PRINTED IN U.S.A.



LittleDiode supplies new, hard to find or obsolete electronic components and semiconductors all over the world.

With over two million different components listed you are sure to find the part you need.

Feel free to visit us today at our online store:

LittleDiode.com

Looking forward to providing you with the best possible service.