

### FEATURES

Differential Nonlinearity:  $\pm 1/2$  LSB  
 Nonlinearity: 0.05%  
 Fast Settling Time: 250 ns  
 High Compliance: -5 V to +10 V  
 Differential Outputs: 0 to 4 mA  
 Guaranteed Monotonicity: 12 Bits  
 Low Full-Scale Tempco: 10 ppm/ $^{\circ}$ C  
 Circuit Interface to TTL, CMOS, ECL, PMOS/NMOS  
 Low Power Consumption: 225 mW  
 Industry Standard AM6012 Pinout  
 Available In Die Form

### GENERAL DESCRIPTION

The DAC312 series of 12-bit multiplying digital-to-analog converters provide high speed with guaranteed performance to 0.012% differential nonlinearity over the full commercial operating temperature range.

The DAC312 combines a 9-bit master D/A converter with a 3-bit (MSBs) segment generator to form an accurate 12-bit D/A converter at low cost. This technique guarantees a very uniform step size (up to  $\pm 1/2$  LSB from the ideal), monotonicity to 12-bits and integral nonlinearity to 0.05% at its differential current outputs. In order to provide the same performance with a 12-bit R-2R ladder design, an integral nonlinearity over temperature of  $1/2$  LSB (0.012%) would be required.

The 250 ns settling time with low glitch energy and low power consumption are achieved by careful attention to the circuit design and stringent process controls. Direct interface with all popular logic families is achieved through the logic threshold terminal.

### PIN CONNECTIONS

20-Pin Hermetic DIP (R-Suffix),  
 20-Pin Plastic DIP (P-Suffix),  
 20-Pin SOL (S-Suffix)

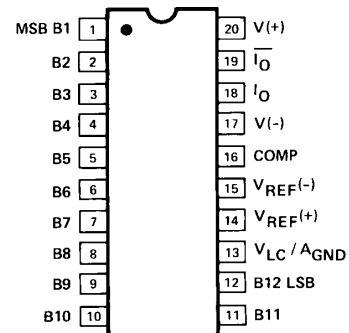

High compliance and low drift characteristics (as low as 10 ppm/ $^{\circ}$ C) are also features of the DAC312 along with an excellent power supply rejection ratio of  $\pm .001\%$  FS/ $\% \Delta V$ . Operating over a power supply range of +5/-11 V to  $\pm 18$  V the device consumes 225 mW at the lower supply voltages with an absolute maximum dissipation of 375 mW at the higher supply levels.

With their guaranteed specifications, single chip reliability and low cost, the DAC312 device makes excellent building blocks for A/D converters, data acquisition systems, video display drivers, programmable test equipment and other applications where low power consumption and complete input/output versatility are required.

### FUNCTIONAL BLOCK DIAGRAM

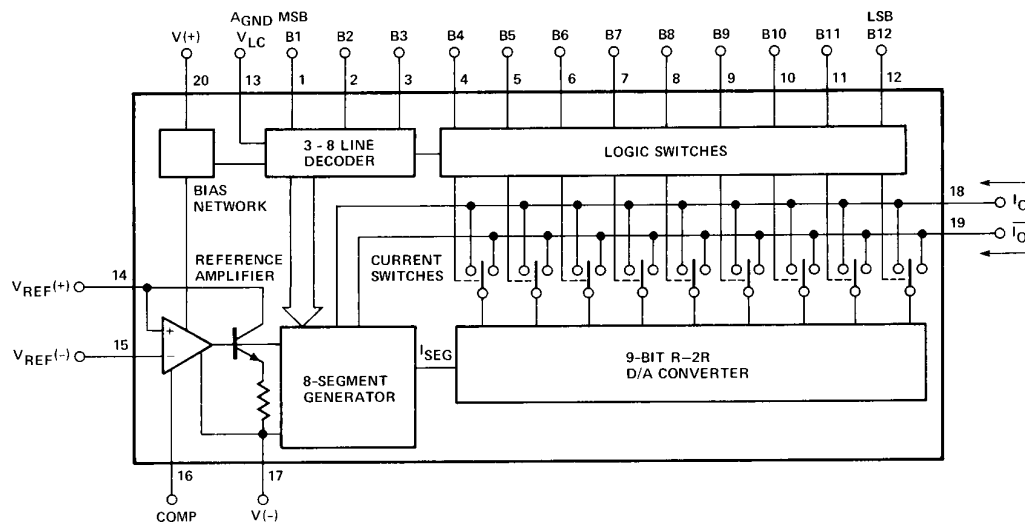

REV. C

Information furnished by Analog Devices is believed to be accurate and reliable. However, no responsibility is assumed by Analog Devices for its use, nor for any infringements of patents or other rights of third parties which may result from its use. No license is granted by implication or otherwise under any patent or patent rights of Analog Devices.

© Analog Devices, Inc., 1996

One Technology Way, P.O. Box 9106, Norwood, MA 02062-9106, U.S.A.  
 Tel: 617/329-4700 Fax: 617/326-8703

# DAC312–SPECIFICATIONS

(@  $V_S = \pm 15\text{ V}$ ,  $I_{REF} = 1.0\text{ mA}$ ,  $0^\circ\text{C} \leq T_A \leq +70^\circ\text{C}$  for DAC312E and  $-40^\circ\text{C} \leq T_A \leq +85^\circ\text{C}$  for DAC312F, DAC312H, unless otherwise noted. Output characteristics refer to both  $I_{OUT}$  and  $\overline{I_{OUT}}$ .)

## ELECTRICAL CHARACTERISTICS

Parameter	Symbol	Conditions	DAC312E			DAC312F			DAC312H			Units
			Min	Typ	Max	Min	Typ	Max	Min	Typ	Max	
Resolution			12			12			12			Bits
Monotonicity			12			12			12			Bits
Differential Nonlinearity	DNL	Deviation from Ideal Step Size <sup>2</sup>			$\pm 0.0125$			$\pm 0.0250$			$\pm 0.0250$	%FS
Nonlinearity	INL	Deviation from Ideal Straight Line <sup>1</sup>			$\pm 0.5$			$\pm 1$			$\pm 1$	LSB
Full-Scale Current	$I_{FS}$	$V_{REF} = 10\text{ V}$ $R_{14} = R_{15} = 10\text{ k}\Omega^2$	3.967	3.999	4.031	3.935	3.999	4.063	3.935	3.999	4.063	mA
Full-Scale Tempco	$TCI_{FS}$			$\pm 5$	$\pm 20$		$\pm 10$	$\pm 40$		$\pm 80$		ppm/ $^\circ\text{C}$
Output Voltage Compliance	$V_{OC}$	DNL Specification Guaranteed over Compliance Range	-5		+10	-5		+10	-5		+10	V
Full-Scale Symmetry	$I_{FSS}$	$ I_{FS}  -  I_{\overline{FS}} $		$\pm 0.4$	$\pm 1$		$\pm 0.4$	$\pm 2$		$\pm 0.4$	$\pm 2$	$\mu\text{A}$
Zero-Scale Current	$I_{ZS}$				0.10			0.10			0.10	$\mu\text{A}$
Settling Time	$t_S$	To $\pm 1/2$ LSB, All Bits Switched ON or OFF <sup>1</sup>		250	500		250	500		250	500	ns
Propagation Delay–All Bits	$t_{PLH}$	All Bits Switched 50% Point		25	50		25	50		25	50	ns
	$t_{PHL}$	Logic Swing to 50% Point Output <sup>1</sup>		25	50		25	50		25	50	ns
Output Resistance	$R_O$			>10			>10			>10		M $\Omega$
Output Capacitance	$C_{OUT}$			20			20			20		pF
Logic Input Levels “0”	$V_{IL}$	$V_{LC} = \text{GND}$			0.8			0.8			0.8	V
Logic Input Levels “1”	$V_{IH}$	$V_{LC} = \text{GND}$	2			2			2			V
Logic Input Current	$I_{IN}$	$V_{IN} = -5\text{ to }+18\text{ V}$			40			40			40	$\mu\text{A}$
Logic Input Swing	$V_{IS}$		-5		+18	-5		+18	-5		+18	V
Reference Bias Current	$I_{15}$		0	-0.5	-2	0	-0.5	-2	0	-0.5	-2	$\mu\text{A}$
Reference Input Slew Rate	$dl/dt$	$R_{14(eq)} = 800\ \Omega$ , $C_C = 0\text{ pF}^1$	4	8		4	8		4	8		mA/ $\mu\text{s}$
Power Supply Sensitivity	$PSSI_{FS+}$	$V_+ = +13.5\text{ V to }+16.5\text{ V}$ , $V_- = -15\text{ V}$		$\pm 0.0005$	$\pm 0.001$		$\pm 0.0005$	$\pm 0.001$		$\pm 0.0005$	$\pm 0.001$	%FS/% $\Delta\text{V}$
	$PSSI_{FS-}$	$V_- = -13.5\text{ V to }-16.5\text{ V}$ , $V_+ = +15\text{ V}$		$\pm 0.00025$	$\pm 0.001$		$\pm 0.00025$	$\pm 0.001$		$\pm 0.00025$	$\pm 0.001$	%FS/% $\Delta\text{V}$
Power Supply Range	$V_+$	$V_{OUT} = 0\text{ V}$	4.5		18	4.5		18	4.5		18	V
	$V_-$	$V_{OUT} = 0\text{ V}$	-18		-10.8	-18		-10.8	-18		-10.8	V
Power Supply Current	$I_+$	$V_+ = +5\text{ V}$ , $V_- = -15\text{ V}$		3.3	7		3.3	7		3.3	7	mA
	$I_-$	$V_+ = +15\text{ V}$ , $V_- = -15\text{ V}$		-13.9	-18		-13.9	-18		-13.9	-18	mA
	$I_+$	$V_+ = +5\text{ V}$ , $V_- = -15\text{ V}$		3.9	7		3.9	7		3.9	7	mA
	$I_-$	$V_+ = +15\text{ V}$ , $V_- = -15\text{ V}$		-13.9	-18		-13.9	-18		-13.9	-18	mA
Power Dissipation	$P_d$	$V_+ = +5\text{ V}$ , $V_- = -15\text{ V}$		225	305		225	305		225	305	mW
		$V_+ = +15\text{ V}$ , $V_- = -15\text{ V}$		267	375		267	375		267	375	mW

## TYPICAL ELECTRICAL CHARACTERISTICS @ $25^\circ\text{C}$ ; $V_S = \pm 15\text{ V}$ , and $I_{REF} = 1.0\text{ mA}$ , unless otherwise noted. Output characteristics refer to both $I_{OUT}$ and $\overline{I_{OUT}}$ .

Parameter	Symbol	Conditions	DAC312N Typical	DAC312G Typical	Units
Reference Input Slew Rate	$dl/dt$		8	8	mA/ $\mu\text{s}$
Propagation Delay	$t_{PLH}$ , $t_{PHL}$	Any Bit	25	25	ns
Settling Time	$t_S$	To $\pm 1/2$ LSB, All Bits Switched ON or OFF.	250	250	ns
Full-Scale	$TCI_{FS}$		$\pm 10$	$\pm 10$	ppm/ $^\circ\text{C}$

## ELECTRICAL CHARACTERISTICS

@  $V_S = \pm 15\text{ V}$ ,  $I_{REF} = 1.0\text{ mA}$ ,  $0^\circ\text{C} \leq T_A \leq 70^\circ\text{C}$  for DAC312E and  $-40^\circ\text{C} \leq T_A \leq +85^\circ\text{C}$  for DAC312F, DAC312H, unless otherwise noted. Output characteristics refer to both  $I_{OUT}$  and  $I_{OUT-}$ . *Continued*

Parameter	Symbol	Conditions	DAC312E			DAC312F			DAC312H			Units
			Min	Typ	Max	Min	Typ	Max	Min	Typ	Max	
Logic Input Levels "0"	$V_{IL}$	$V_{LC} = \text{GND}$			0.8			0.8			0.8	V
Logic Input Levels "1"	$V_{IH}$	$V_{LC} = \text{GND}$	2			2			2			V
Logic Input Current	$I_{IN}$	$V_{IN} = -5\text{ V to }+18\text{ V}$			40			40			40	$\mu\text{A}$
Logic Input Swing	$V_{IS}$		-5		+18	-5		+18	-5		+18	V
Reference Bias Current	$I_{15}$		0	-0.5	-2	0	-0.5	-2	0	-0.5	-2	$\mu\text{A}$
Reference Input Slew Rate	$dl/dt$	$R_{14(eq)} = 800\ \Omega$ $C_C = 0\ \text{pF}$ (Note 1)	4	8		4	8		4	8		$\text{mA}/\mu\text{s}$
Power Supply Sensitivity	$PSSI_{FS+}$	$V_+ = +13.5\text{ V to }+16.5\text{ V}$ , $V_- = -15\text{ V}$		$\pm 0.0005$	$\pm 0.001$		$\pm 0.0005$	$\pm 0.001$		$\pm 0.0005$	$\pm 0.001$	%FS/% $\Delta V$
	$PSSI_{FS-}$	$V_- = -13.5\text{ V to }-16.5\text{ V}$ , $V_+ = +15\text{ V}$		$\pm 0.00025$	$\pm 0.001$		$\pm 0.00025$	$\pm 0.001$		$\pm 0.00025$	$\pm 0.001$	%FS/% $\Delta V$
Power Supply Range	$V_+$ $V_-$	$V_{OUT} = 0\text{ V}$	4.5 -18		18 -10.8	4.5 -18		18 -10.8	4.5 -18		18 -10.8	V
Power Supply Current	$I_+$			3.3	7		3.3	7		3.3	7	mA
	$I_-$	$V_+ = +5\text{ V}$ , $V_- = -15\text{ V}$		-13.9	-18		-13.9	-18		-13.9	-18	
	$I_+$	$V_+ = +15\text{ V}$ , $V_- = -15\text{ V}$		3.9	7		3.9	7		3.9	7	
	$I_-$			-13.9	-18		-13.9	-18		-13.9	-18	
Power Dissipation	$P_d$	$V_+ = +5\text{ V}$ , $V_- = -15\text{ V}$ $V_+ = +15\text{ V}$ , $V_- = -15\text{ V}$		225	305		225	305		225	305	mW

## NOTES

<sup>1</sup>Guaranteed by design.<sup>2</sup> $T_A = +25^\circ\text{C}$  for DAC312H grade only.

Specifications subject to change without notice.

# DAC312

## WAFER TEST LIMITS @ $V_S = \pm 15\text{ V}$ , $I_{REF} = 1.0\text{ mA}$ , $T_A = 25^\circ\text{C}$ , unless otherwise noted. Output characteristics refer to both $I_{OUT}$ and $\overline{I_{OUT}}$ .

Parameter	Symbol	Conditions	DAC312N Limit	DAC312G Limit	Units
Resolution			12	12	Bits min
Monotonicity			12	12	Bits min
Nonlinearity			$\pm 0.05$	$\pm 0.05$	%FS max
Output Voltage Compliance	$V_{OC}$	Full-Scale Current Change $< 1/2$ LSB	+10 -5	+10 -5	V max V min
Full-Scale Current		$V_{REF} = 10.000\text{ V}$ $R_{14}, R_{15} = 10.000\text{ k}\Omega$	4.031 3.967	4.063 3.935	mA max mA min
Full-Scale Symmetry	$I_{FSS}$		$\pm 1$	$\pm 2$	$\mu\text{A}$ max
Zero-Scale Current	$I_{ZS}$		0.1	0.1	$\mu\text{A}$ max
Differential Nonlinearity	DNL	Deviation from Ideal Step Size	$\pm 0.012$ $\pm 1/2$	$\pm 0.025$ $\pm 1$	%FS max Bits (LSB) max
Logic Input Levels "0"	$V_{IL}$	$V_{LC} = \text{GND}$	0.8	0.8	V max
Logic Input Levels "1"	$V_{IH}$	$V_{LC} = \text{GND}$	2	2	V min
Logic Input Swing	$V_{IS}$		+18 -5	+18 -5	V max V min
Reference Bias Current	$I_{15}$		-2	-2	$\mu\text{A}$ max
Power Supply Sensitivity	$PSSI_{FS+}$ $PSSI_{FS-}$	$V_+ = +13.5\text{ V}$ to $+16.5\text{ V}$ , $V_- = -15\text{ V}$ $V_- = -13.5\text{ V}$ to $-16.5\text{ V}$ , $V_+ = +15\text{ V}$	$\pm 0.001$ $\pm 0.001$	$\pm 0.001$ $\pm 0.001$	%/%max
Power Supply Current	$I_+$ $I_-$	$V_S = +15\text{ V}$ $I_{REF} \leq 1.0\text{ mA}$	7 -18	7 -18	mA max
Power Dissipation	$P_D$	$V_S = +15\text{ V}$ $I_{REF} \leq 1.0\text{ mA}$	375	375	mW max

### NOTE

Electrical tests are performed at wafer probe to the limits shown. Due to variations in assembly methods and normal yield loss, yield after packaging is not guaranteed for standard product dice. Consult factory to negotiate specifications based on dice lot qualification through sample lot assembly and testing.

### DICE CHARACTERISTICS

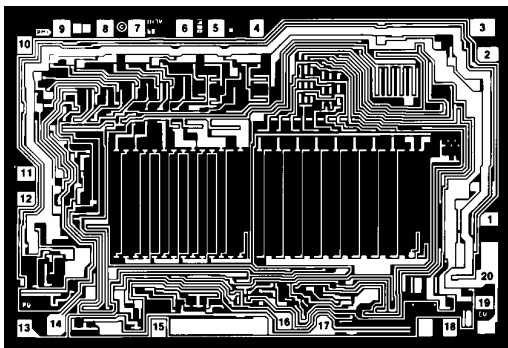

- |             |                      |
|-------------|----------------------|
| 1. B1 (MSB) | 11. B11              |
| 2. B2       | 12. B12 (LSB)        |
| 3. B3       | 13. $V_{LC}/A_{GND}$ |
| 4. B4       | 14. $V_{REF}(+)$     |
| 5. B5       | 15. $V_{REF}(-)$     |
| 6. B6       | 16. COMP             |
| 7. B7       | 17. $\overline{V_-}$ |
| 8. B8       | 18. $\overline{I_O}$ |
| 9. B9       | 19. $I_O$            |
| 10. B10     | 20. $V_+$            |

DIE SIZE  $0.141 \times 0.096$  inch, 13,536 sq. mils ( $3.58 \times 2.44$  mm, 8.74 sq. mm)

## ABSOLUTE MAXIMUM RATINGS<sup>1</sup>

Operating Temperature	
DAC312E	0°C to +70°C
DAC312F, DAC312H	-40°C to +85°C
Junction Temperature	
	-65°C to +150°C
Storage Temperature (T <sub>j</sub> )	
	-65°C to +125°C
Lead Temperature (Soldering, 60 sec)	
	300°C
Power Supply Voltage	
	±18 V
Logic Inputs	
	-5 V to +18 V
Analog Current Outputs	
	-8 V to +12 V
Reference Inputs V <sub>14</sub> , V <sub>15</sub>	
	V- to V+
Reference Input Differential Voltage (V <sub>14</sub> , V <sub>15</sub> )	
	±18 V
Reference Input Current (I <sub>14</sub> )	
	1.25 mA

Package Type	$\theta_{JA}$ <sup>2</sup>	$\theta_{JC}$	Units
20-Pin Hermetic DIP (R)	76	11	°C/W
20-Pin Plastic DIP (P)	69	27	°C/W
20-Pin SOL (S)	88	25	°C/W

### NOTES

<sup>1</sup>Absolute maximum ratings apply to both DICE and packaged parts, unless otherwise noted.

<sup>2</sup> $\theta_{JA}$  is specified for worst case mounting conditions, i.e.,  $\theta_{JA}$  is specified for device in socket for cerdip and P-DIP packages;  $\theta_{JA}$  is specified for device soldered to printed circuit board for SOL package.

## ORDERING GUIDE<sup>1</sup>

Model	DNL	Temperature Range	Package Description	Package Option
DAC312ER <sup>2</sup>	±1/2 LSB	0°C to +70°C	Cerdip-20	Q-20
DAC312FR	±1 LSB	-40°C to +85°C	Cerdip-20	Q-20
DAC312BR/883	±1 LSB	-55°C to +125°C	Cerdip-20	Q-20
DAC312HP	±1 LSB	-40°C to +85°C	Plastic DIP-20	N-20
DAC312HS	±1 LSB	-40°C to +85°C	SOL-20	R-20

### NOTES

<sup>1</sup>Burn-in is available on commercial and industrial temperature range parts in cerdip, plastic DIP, and TO-can packages.

<sup>2</sup>For devices processed in total compliance to MIL-STD-883, add/883 after part number. Consult factory for 883 data sheet.

## CAUTION

ESD (electrostatic discharge) sensitive device. Electrostatic charges as high as 4000 V readily accumulate on the human body and test equipment and can discharge without detection. Although the DAC312 features proprietary ESD protection circuitry, permanent damage may occur on devices subjected to high energy electrostatic discharges. Therefore, proper ESD precautions are recommended to avoid performance degradation or loss of functionality.



# DAC312

## TYPICAL PERFORMANCE CHARACTERISTICS

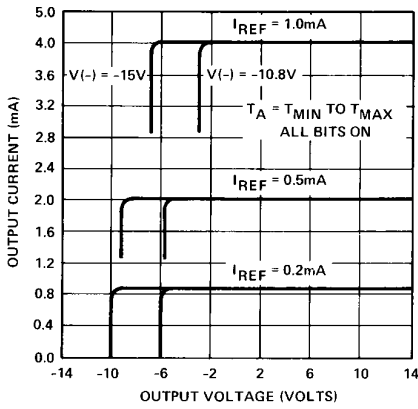

Output Current vs. Output Voltage (Output Voltage Compliance)

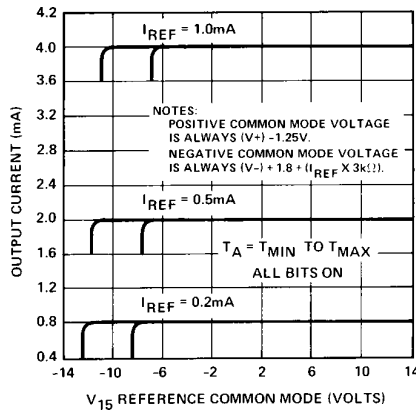

Reference Amplifier Common-Mode Range

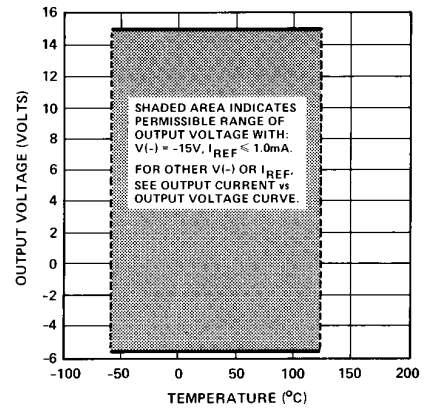

Output Compliance vs. Temperature

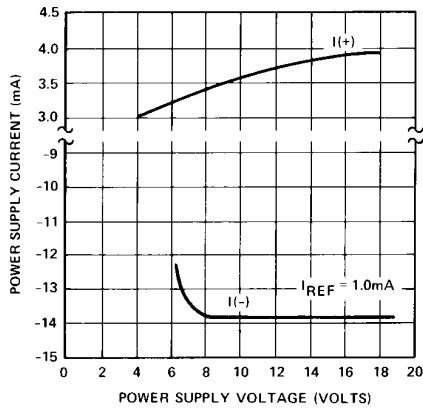

Power Supply Current vs. Power Supply Voltage

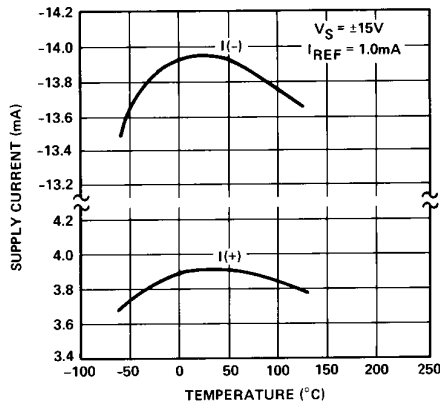

Power Supply Current vs. Temperature

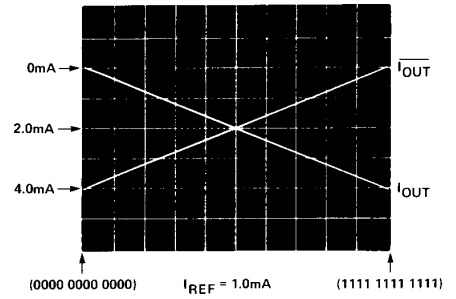

True and Complementary Output Operation

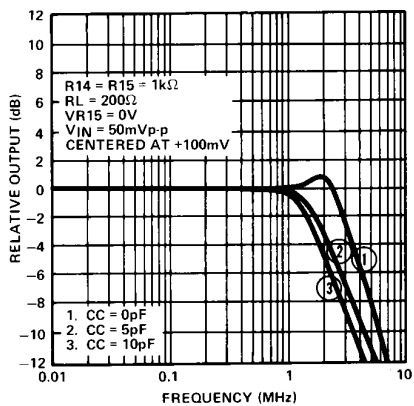

Reference Amplifier Small-Signal Frequency Response

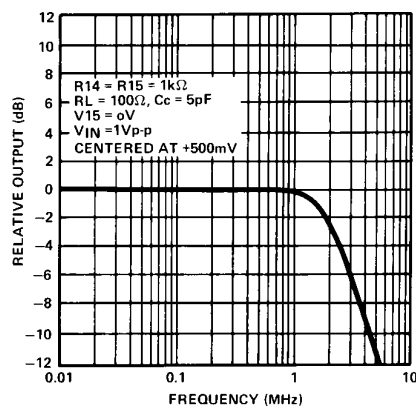

Reference Amplifier Large-Signal Frequency Response

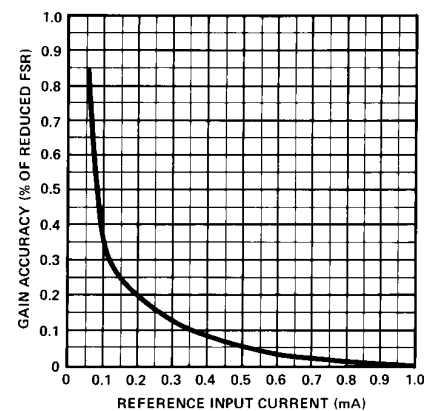

Gain Accuracy vs. Reference Current



# DAC312

## BASIC CONNECTIONS

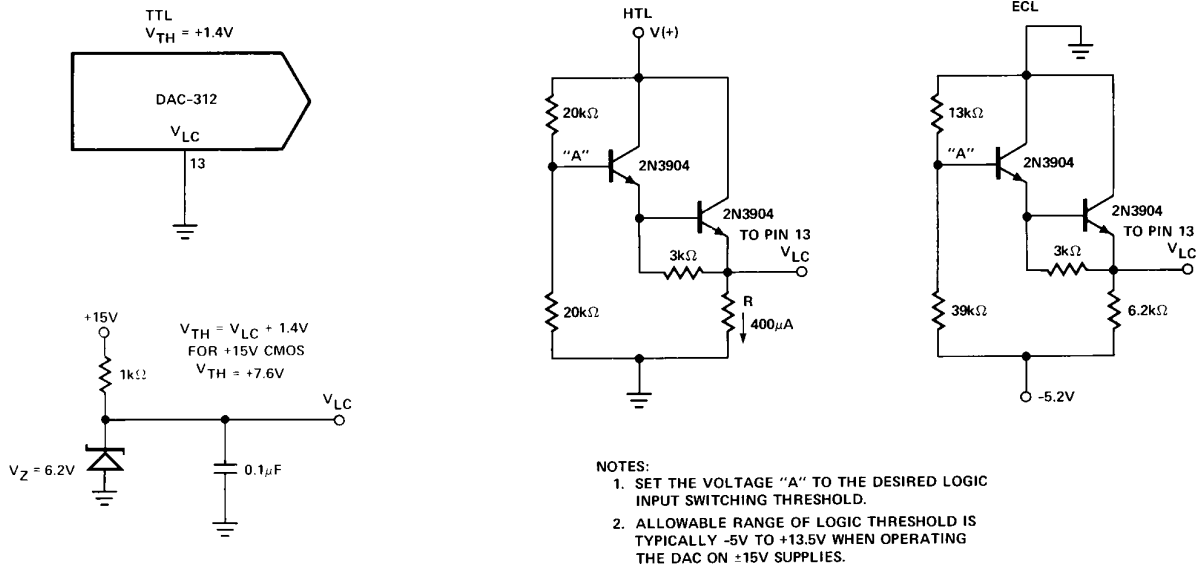

## Interfacing with Various Logic Families

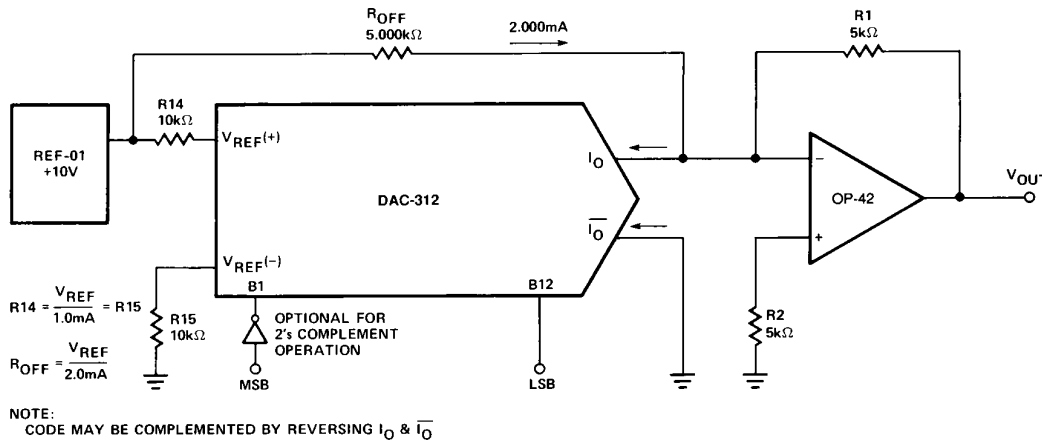

## Bipolar Offset (True Zero)

Code Format	Output Scale	MSB												$I_O$ (mA)	$\bar{I}_O$ (mA)	$V_{OUT}$	
		B1	B2	B3	B4	B5	B6	B7	B8	B9	B10	B11	B12				LSB
Offset Binary; True Zero Output.	Positive Full-Scale	1	1	1	1	1	1	1	1	1	1	1	1	1	3.999	0.000	9.9951
	Positive Full-Scale -LSB	1	1	1	1	1	1	1	1	1	1	1	1	0	3.998	0.001	9.9902
	+LSB	1	0	0	0	0	0	0	0	0	0	0	0	1	2.001	1.998	0.0049
	Zero-Scale	1	0	0	0	0	0	0	0	0	0	0	0	0	2.000	1.999	0.000
	-LSB	0	1	1	1	1	1	1	1	1	1	1	1	1	1.999	2.000	-0.0049
	Negative Full-Scale +LSB	0	0	0	0	0	0	0	0	0	0	0	0	1	0.001	3.998	-9.9951
	Negative Full-Scale	0	0	0	0	0	0	0	0	0	0	0	0	0	0.000	3.999	-10.000
2s Complement; True Zero Output MSB Complemented (Need Inverter at B1).	Positive Full-Scale	0	1	1	1	1	1	1	1	1	1	1	1	1	3.999	0.000	9.9951
	Positive Full-Scale -LSB	0	1	1	1	1	1	1	1	1	1	1	1	0	3.998	0.001	9.9902
	+1 LSB	0	0	0	0	0	0	0	0	0	0	0	0	1	2.001	1.998	0.0049
	Zero-Scale	0	0	0	0	0	0	0	0	0	0	0	0	0	2.000	1.999	0.000
	-1 LSB	1	1	1	1	1	1	1	1	1	1	1	1	1	1.999	2.000	-0.0049
	Negative Full-Scale +LSB	1	0	0	0	0	0	0	0	0	0	0	0	1	0.001	3.998	-9.9951
	Negative Full-Scale	1	0	0	0	0	0	0	0	0	0	0	0	0	0.000	3.999	-10.000

## BASIC CONNECTIONS

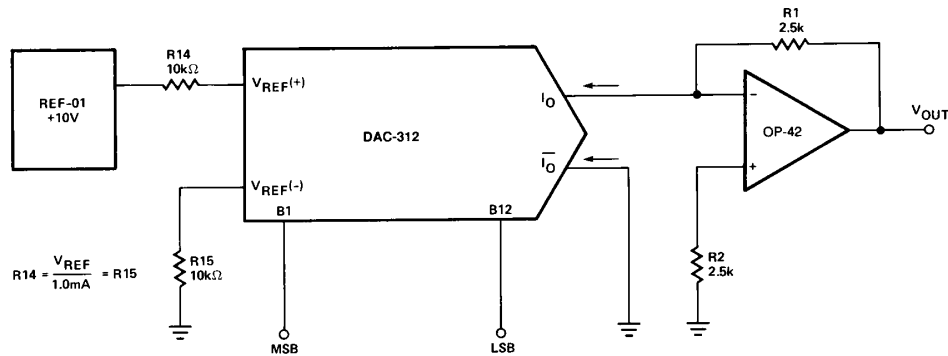

NOTE:  
CODE MAY BE COMPLEMENTED BY REVERSING  $I_O$  &  $\bar{I}_O$

*Basic Unipolar Operation*

Code Format	Output Scale	MSB												LSB		$I_O$ (mA)	$\bar{I}_O$ (mA)	$V_{OUT}$
		B1	B2	B3	B4	B5	B6	B7	B8	B9	B10	B11	B12					
Straight Binary; Unipolar with True Input Code, True Zero Output.	Positive Full-Scale	1	1	1	1	1	1	1	1	1	1	1	1	3.999	0.000	9.9976		
	Positive Full-Scale -LSB	1	1	1	1	1	1	1	1	1	1	1	0	3.998	0.001	9.9951		
	LSB	0	0	0	0	0	0	0	0	0	0	0	1	0.001	3.998	0.0024		
	Zero-Scale	0	0	0	0	0	0	0	0	0	0	0	0	0.000	3.999	0.0000		
Complementary Binary; Unipolar with Complementary Input Code, True Zero Output.	Positive Full-Scale	0	0	0	0	0	0	0	0	0	0	0	0	0.000	3.999	9.9976		
	Positive full-Scale -LSB	0	0	0	0	0	0	0	0	0	0	0	1	0.001	3.998	9.9951		
	LSB	1	1	1	1	1	1	1	1	1	1	1	0	3.998	0.001	0.0024		
	Zero-Scale	1	1	1	1	1	1	1	1	1	1	1	1	3.999	0.000	0.0000		

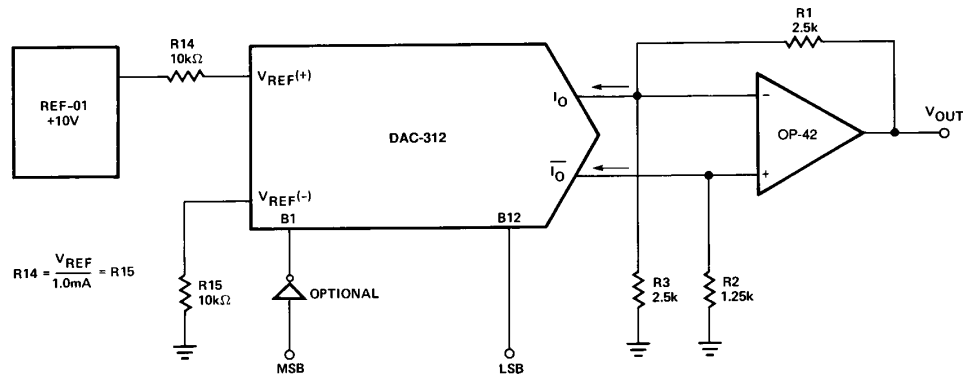

NOTE:  
CODE MAY BE COMPLEMENTED BY REVERSING  $I_O$  &  $\bar{I}_O$

*Symmetrical Offset Operation*

Code Format	Output Scale	MSB												LSB		$I_O$ (mA)	$\bar{I}_O$ (mA)	$V_{OUT}$
		B1	B2	B3	B4	B5	B6	B7	B8	B9	B10	B11	B12					
Straight Offset Binary; Symmetrical about Zero, No True Zero Output.	Positive Full-Scale	1	1	1	1	1	1	1	1	1	1	1	1	3.999	0.00	9.9976		
	Positive Full-Scale -LSB	1	1	1	1	1	1	1	1	1	1	1	0	3.998	0.001	9.9927		
	(+) Zero-Scale	1	0	0	0	0	0	0	0	0	0	0	0	2.000	1.999	0.0024		
	(-) Zero-Scale	0	1	1	1	1	1	1	1	1	1	1	1	1.999	2.000	-0.0024		
	Negative Full-Scale -LSB	0	0	0	0	0	0	0	0	0	0	0	1	0.001	3.998	-9.9927		
	Negative Full-Scale	0	0	0	0	0	0	0	0	0	0	0	0	0.000	3.999	-9.9976		
1s Complement; Symmetrical about Zero, No True Zero Output. MSB Complemented (Need Inverter at B1).	Positive Full-Scale	0	1	1	1	1	1	1	1	1	1	1	1	3.999	0.000	9.9976		
	Positive Full-Scale -LSB	0	1	1	1	1	1	1	1	1	1	1	0	3.998	0.001	9.9927		
	(+) Zero-Scale	0	0	0	0	0	0	0	0	0	0	0	0	2.000	1.999	0.0024		
	(-) Zero-Scale	1	1	1	1	1	1	1	1	1	1	1	1	1.999	2.000	-0.0024		
	Negative Full-Scale -LSB	1	0	0	0	0	0	0	0	0	0	0	1	0.001	3.998	-9.9927		
	Negative Full-Scale	1	0	0	0	0	0	0	0	0	0	0	0	0.000	3.999	-9.9976		

# DAC312

## APPLICATIONS INFORMATION REFERENCE AMPLIFIER SETUP

The DAC312 is a multiplying D/A converter in which the output current is the product of a digital number and the input reference current. The reference current may be fixed or may vary from nearly zero to +1.0 mA. The full range output current is a linear function of the reference current and is given by:

$$I_{FR} = \frac{4095}{4096} \times 4 \times (I_{REF}) = 3.999 I_{REF},$$

*where  $I_{REF} = I_{I4}$*

In positive reference applications, an external positive reference voltage forces current through R14 into the  $V_{REF(+)}$  terminal (pin 14) of the reference amplifier. Alternatively, a negative reference may be applied to  $V_{REF(-)}$  at pin 15. Reference current flows from ground through R14 into  $V_{REF(+)}$  as in the positive reference case. This negative reference connection has the advantage of a very high impedance presented at pin 15. The voltage at pin 14 is equal to and tracks the voltage at pin 15 due to the high gain of the internal reference amplifier. R15 (nominally equal to R14) is used to cancel bias current errors.

Bipolar references may be accommodated by offsetting  $V_{REF}$  or pin 15. The negative common-mode range of the reference amplifier is given by:  $V_{CM-} = V_-$  plus  $(I_{REF} \times 3 \text{ k}\Omega)$  plus 1.23 V. The positive common-mode range is  $V_+$  less 1.8 V.

When a dc reference is used, a reference bypass capacitor is recommended. A 5.0 V TTL logic supply is not recommended as a reference. If a regulated power supply is used as a reference, R14 should be split into two resistors with the junction bypassed to ground with a 0.1  $\mu\text{F}$  capacitor.

For most applications the tight relationship between  $I_{REF}$  and  $I_{FS}$  will eliminate the need for trimming  $I_{REF}$ . If required, full scale trimming may be accomplished by adjusting the value of R14, or by using a potentiometer for R14. An improved method of full-scale trimming which eliminates potentiometer T.C. effects is shown in the Recommended Full-Scale Adjustment circuit.

The reference amplifier must be compensated by using a capacitor from pin 16 to  $V_-$ . For fixed reference operation, a 0.01  $\mu\text{F}$  capacitor is recommended. For variable reference applications, see section entitled "Reference Amplifier Compensation for Multiplying Applications."

## MULTIPLYING OPERATION

The DAC312 provides excellent multiplying performance with an extremely linear relationship between  $I_{FS}$  and  $I_{REF}$  over a range of 1 mA to 1  $\mu\text{A}$ . Monotonic operation is maintained over a typical range of  $I_{REF}$  from 100  $\mu\text{A}$  to 1.0 mA. Although some degradation of gain accuracy will be realized at reduced values of  $I_{REF}$ . (See Gain Accuracy vs. Reference Current).

## REFERENCE AMPLIFIER COMPENSATION FOR MULTIPLYING APPLICATIONS

AC reference applications will require the reference amplifier to be compensated using a capacitor from pin 16 to  $V_-$ . The value of this capacitor depends on the impedance presented to pin 14 for R14 values of 1.0  $\Omega$ , 2.5  $\Omega$  and 5.0 k $\Omega$ , minimum values of  $C_C$  are 5 pF, 10 pF, and 25 pF. Larger values of R14 require proportionately increased values of  $C_C$  for proper phase margin.

For fastest response to a pulse, low values of R14 enabling small  $C_C$  values should be used. If pin 14 is driven by a high impedance such as a transistor current source, none of the above values will suffice and the amplifier must be heavily compensated which will decrease overall bandwidth and slew rate. For R14 = 1 k $\Omega$  and  $C_C = 5$  pF, the reference amplifier slews at 4 mA/ $\mu\text{s}$  enabling a transition from  $I_{REF} = 0$  to  $I_{REF} = 1$  mA in 250 ns.

Operation with pulse inputs to the reference amplifier may be accommodated by an alternate compensation scheme. This technique provides lowest full-scale transition times. An internal clamp allows quick recovery of the reference amplifier from a cutoff ( $I_{REF} = 0$ ) condition. Full-scale transition (0 mA to 1 mA) occurs in 62.5 ns when the equivalent impedance at pin 14 is 800  $\Omega$  and  $C_C = 0$ . This yields a reference slew rate of 8 mA/ $\mu\text{s}$  which is relatively independent of  $R_{IN}$  and  $V_{IN}$  values.

## LOGIC INPUTS

The DAC312 design incorporates a unique logic input circuit which enables direct interface to all popular logic families and provides maximum noise immunity. This feature is made possible by the large input swing capability, 40  $\mu\text{A}$  logic input current, and completely adjustable logic threshold voltage. For  $V_- = -15$  V, the logic inputs may swing between -5 V and +10 V. This enables direct interface with +15 V CMOS logic, even when the DAC312 is powered from a +5 V supply. Minimum input logic swing and minimum logic threshold voltage are given by:  $V_-$  plus  $(I_{REF} \times 3 \text{ k}\Omega)$  plus 1.8 V. The logic threshold may be adjusted over a wide range by placing an appropriate voltage at the logic threshold control pin (pin 13,  $V_{LC}$ ). The appropriate graph shows the relationship between  $V_{LC}$  and  $V_{TH}$  over the temperature range, with  $V_{TH}$  nominally 1.4 above  $V_{LC}$ . For TTL interface, simply ground pin 13. When interfacing ECL, an  $I_{REF} \leq 1$  mA is recommended. For interfacing other logic families, see block titled "Interfacing With Various Logic Families". For general setup of the logic control circuit, it should be noted that pin 13 will sink 7 mA typical; external circuitry should be designed to accommodate this current.

### ANALOG OUTPUT CURRENTS

Both true and complemented output sink currents are provided where  $I_O + \bar{I}_O = I_{FR}$ . Current appears at the true output when a “1” is applied to each logic input. As the binary count increases, the sink current at pin 18 increases proportionally, in the fashion of a “positive logic” D/A converter. When a “0” is applied to any input bit, that current is turned off at pin 18 and turned on at pin 19. A decreasing logic count increases  $\bar{I}_O$  as in a negative or inverted logic D/A converter. Both outputs may be used simultaneously. If one of the outputs is not required it must still be connected to ground or to a point capable of sourcing  $I_{FR}$ ; do not leave an unused output pin open.

Both outputs have an extremely wide voltage compliance enabling fast direct current-to-voltage conversion through a resistor tied to ground or other voltage source. Positive compliance is 25 V above  $V_-$  and is independent of the positive supply. Negative compliance is +10 V above  $V_-$ .

The dual outputs enable double the usual peak-to-peak load swing when driving loads in quasi-differential fashion. This feature is especially useful in cable driving, CRT deflection and in other balanced applications such as driving center-tapped coils and transformers.

### POWER SUPPLIES

The DAC312 operates over a wide range of power supply voltages from a total supply of 20 V to 36 V. When operating with  $V_-$  supplies of  $-10$  V or less,  $I_{REF} \leq 1$  mA is recommended. Low reference current operation decreases power consumption and increases negative compliance, reference amplifier negative common-mode range, negative logic input range, and negative logic threshold range; consult the various figures for guidance. For example, operation at  $-9$  V with  $I_{REF} = 1$  mA is not recommended because negative output compliance would be reduced to near zero. Operation from lower supplies is possible, however at least 8 V total must be applied to insure turn-on of the internal bias network.

Symmetrical supplies are not required, as the DAC312 is quite insensitive to variations in supply voltage. Battery operation is feasible as no ground connection is required; however, an artificial ground may be used to insure logic swings, etc. remain between acceptable limits.

### TEMPERATURE PERFORMANCE

The nonlinearity and monotonicity specifications of the DAC312 are guaranteed to apply over the entire rated operating temperature range. Full-scale output current drift is tight, typically  $\pm 10$  ppm/ $^{\circ}$ C, with zero-scale output current and drift essentially negligible compared to 1/2 LSB.

The temperature coefficient of the reference resistor R14 should match and track that of the output resistor for minimum overall

full-scale drift. Settling times of the DAC312 decrease approximately 10% at  $-55^{\circ}$ C; at  $+125^{\circ}$ C an increase of about 15% is typical.

### SETTLING TIME

The DAC312 is capable of extremely fast settling times; typically 250 ns at  $I_{REF} = 1.0$  mA. Judicious circuit design and careful board layout must be employed to obtain full performance potential during testing and application. The logic switch design enables propagation delays of only 25 ns for each of the 12 bits. Settling time to within 1/2 LSB of the LSB is therefore 25 ns, with each progressively larger bit taking successively longer. The MSB settles in 250 ns, thus determining the overall settling time of 250 ns. Settling to 10-bit accuracy requires about 90 ns to 130 ns. The output capacitance of the DAC312 including the package is approximately 20 pF; therefore, the output RC time constant dominates settling time if  $R_L > 500 \Omega$ .

Settling time and propagation delay are relatively insensitive to logic input amplitude and rise and fall times, due to the high gain of the logic switches. Settling time also remains essentially constant for  $I_{REF}$  values down to 0.5 mA, with gradual increases for lower  $I_{REF}$  values lies in the ability to attain a given output level with lower load resistors, thus reducing the output RC time constant.

Measurement of the settling time requires the ability to accurately resolve  $\pm 1/2$  LSB of current, which is  $\pm 500$  nA for 4 mA FSR. In order to assure the measurement is of the actual settling time and not the RC time of the output network, the resistive termination on the output of the DAC must be  $500 \Omega$  or less. This does, however, place certain limitations on the testing apparatus. At  $I_{REF}$  values of less than 0.5 mA, it is difficult to prevent RC damping of the output and maintain adequate sensitivity. Because the DAC312 has 8 equal current sources for the 3 most significant bits, the major carry occurs at the code change of 000111111111 to 111000000000. The worst case settling time occurs at the zero to full-scale transition and it requires 9.2 time constants for the DAC output to settle to within  $\pm 1/2$  LSB (0.0125%) of its final value.

The DAC312 switching transients or “glitches” are on the order of 500 mV-ns. This is most evident when switching through the major carry and may be further reduced by adding small capacitive loads at the output with a minor sacrifice in transition speeds.

Fastest operation can be obtained by using short leads, minimizing output capacitance and load resistor values, and by adequate bypassing at the supply, reference, and  $V_{LC}$  terminals. Supplies do not require large electrolytic bypass capacitors as the supply current drain is independent of input logic states; 0.1  $\mu$ F capacitors at the supply pins provide full transient protection.

# DAC312

## DIFFERENTIAL VS. INTEGRAL NONLINEARITY

Integral nonlinearity, for the purposes of the discussion, refers to the "straightness" of the line drawn through the individual response points of a data converter. Differential nonlinearity, on the other hand, refers to the deviation of the spacing of the adjacent points from a 1 LSB ideal spacing. Both may be expressed as either a percentage of full-scale output or as fractional LSBs or both. The following figures define the manner in which these parameters are specified. The left figure shows a portion of the transfer curve of a DAC with 1/2 LSB INL and the (implied) DNL spec of 1 LSB. Below this is a graphic representation of the way this would appear on a CRT, for example, if the D/A converter output were to be applied to the Y input of a CRT as shown in the application schematic titled "CRT Display Drive." On the right is a portion of the transfer curve of a DAC specified for 2 LSB INL with 1/2 LSB DNL specified and the graphic display below it.

One of the characteristics of an R-2R DAC in standard form is that any transition which causes a zero LSB change (i.e., the same output for two different codes) will exhibit the same output each time that transition occurs. The same holds true for transitions causing a 2 LSB change. These two problem transitions are allowable for the standard definition of monotonicity and also allow the device to be specified very tightly for INL. The major problem arising from this error type is in A/D converter implementations. Inputs producing the same output are now represented by ambiguous output codes for an identical input. Also, 2 LSB gaps can cause large errors at those input levels (assuming 1/2 LSB quantizing levels). It can be seen from the two figures that the DNL specified D/A converter will yield much finer grained data than the INL specified part, thus improving the ability of the A/D to resolve changes in the analog input.

## DIFFERENTIAL LINEARITY COMPARISON

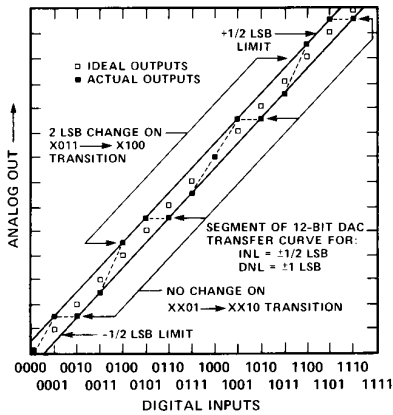

D/A Converter with  $\pm 1/2$  LSB INL,  $\pm 1$  LSB DNL

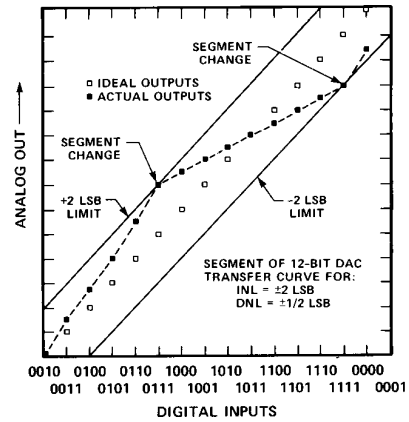

D/A Converter with  $\pm 2$  LSB INL,  $\pm 1/2$  LSB DNL

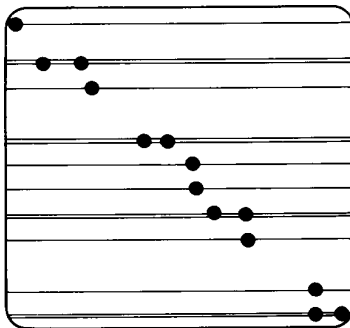

Video Deflection by DACs

ENLARGED "POSITIONAL" OUTPUTS

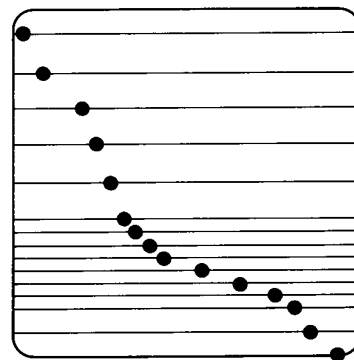

Video Deflection by DACs

ENLARGED "POSITIONAL" OUTPUTS

## DESCRIPTION OF OPERATION

The DAC312 is divided into two major sections, an 8 segment generator and a 9-bit master/slave D/A converter. In operation the device performs as follows (see Simplified Schematic).

The three most significant bits (MSBs) are inputs to a 3-to-8 line decoder. The selected resistor ( $R_5$  in the figure) is connected to the master/slave 9-bit D/A converter. All lower order resistors ( $R_1$  through  $R_4$ ) are summed into the  $I_O$  line, while all higher order resistors ( $R_6$  through  $R_8$ ) are summed into the  $\bar{I}_O$  line. The  $R_5$  current supplies 512 steps of current (0 mA to 0.499 mA for a 1 mA reference current) which are also summed into the  $I_O$  or  $\bar{I}_O$  lines depending on the bits selected. In the figure, the code selected is: 100 11000000. Therefore, 2 mA ( $4 \times 0.5$  mA/segment) + 0.375 mA (from master/slave D/A converter) are summed into  $I_O$  giving an  $I_O$  of 2.375 mA.  $\bar{I}_O$  has a current of 1.625 mA with this code. As the three MSB's are incremented, each successively higher code adds 0.5 mA to  $\bar{I}_O$  and subtracts 0.5 mA from  $I_O$ , with the selected resistor feeding its current to the master/slave D/A converter; thus each increment of the 3 MSB's allows the current in the 9-bit D/A converter to be added to a pedestal consisting of the sum of all lower order currents from the segment generator. This configuration guarantees monotonicity.

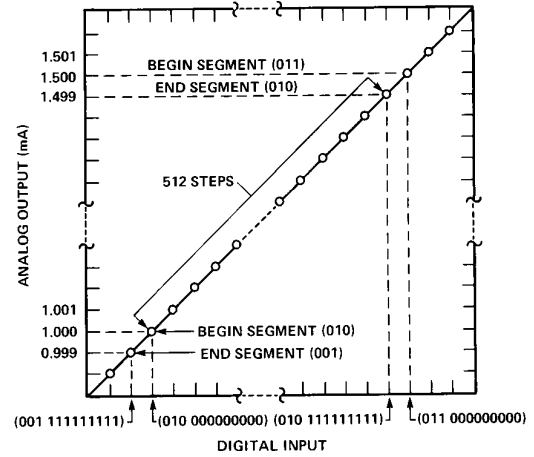

Expanded Transfer Characteristic Segment (001 010 011)

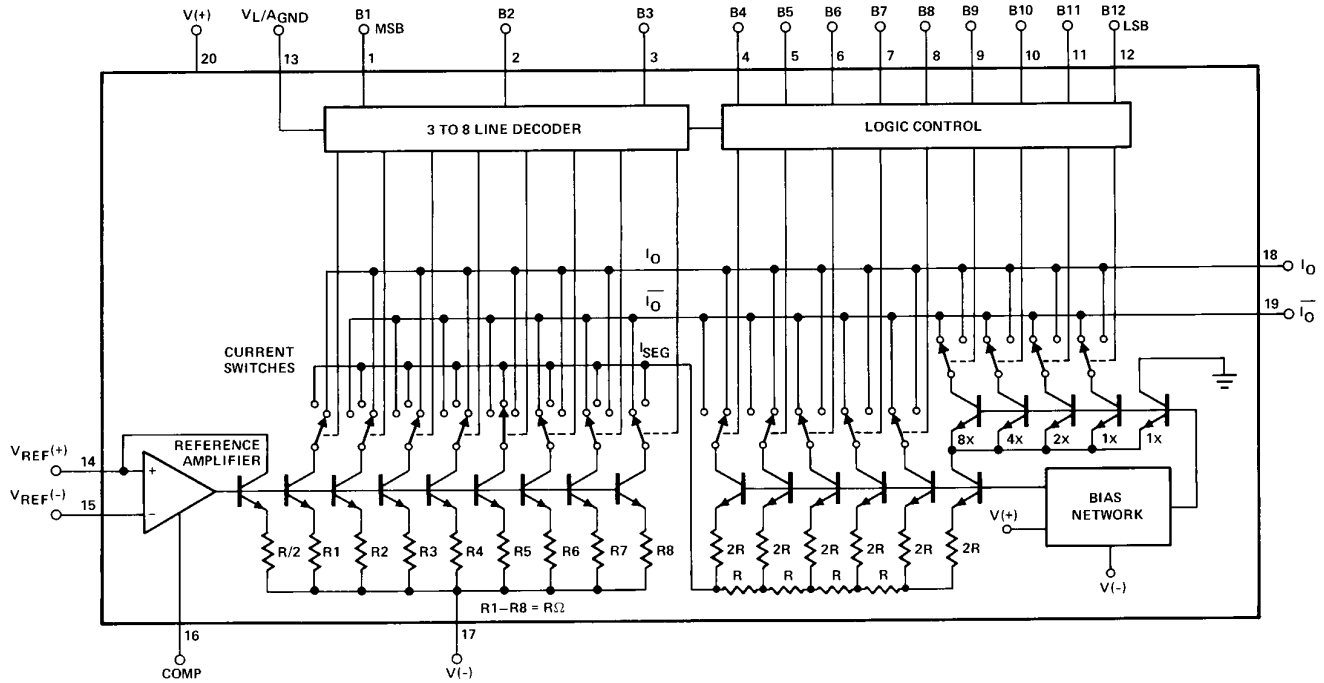

Simplified Schematic

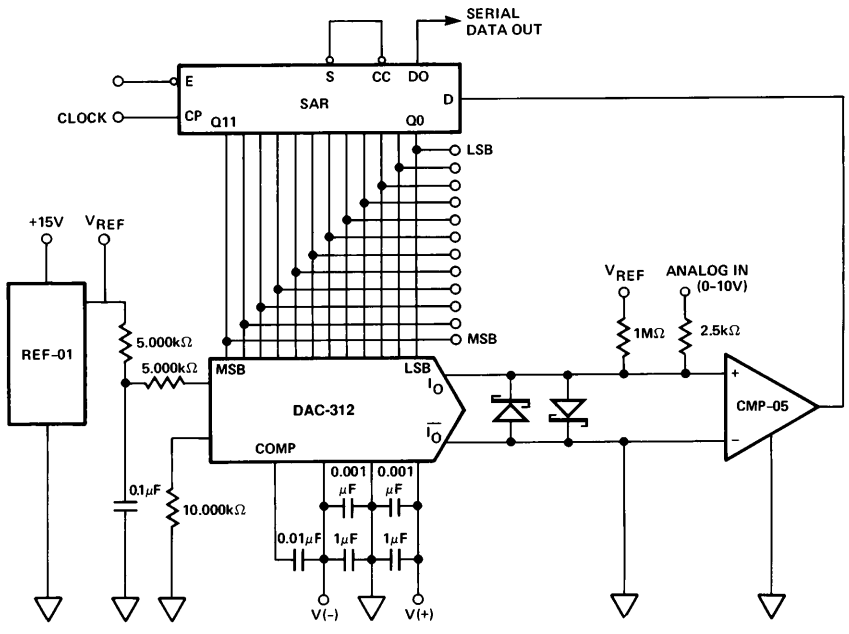

NOTE:  
 DEVICE(S) CONNECTED TO ANALOG INPUT MUST BE CAPABLE OF SOURCING 4.0mA.  
 A BUFFER (eg. BUF-03) MAY BE REQUIRED.

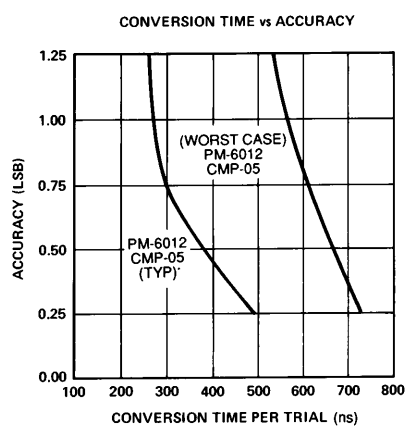

CONVERSION TIME (ns)	TYP	WORST CASE
SAR	33	55
CMP-05	92	125
<b>TOTAL</b>	<b>375ns</b>	<b>680ns</b>
<b>X 13</b>	<b>4.9μS</b>	<b>8.8μS</b>

**12-Bit Fast A/D Converter**  
**Outline Dimensions**  
 Dimension shown in inches and (mm).

**20-Lead Plastic DIP (N-20)**

**20-Lead Cerdip (Q-20)**

**20-Lead Wide Body SOL (R-20)**

000000000

PRINTED IN U.S.A.



LittleDiode supplies new, hard to find or obsolete electronic components and semiconductors all over the world.

With over two million different components listed you are sure to find the part you need.

Feel free to visit us today at our online store:

[LittleDiode.com](http://LittleDiode.com)

Looking forward to providing you with the best possible service.