

100MHz CMOS/DMOS Wideband Analog Switch



CWB211

FEATURES

- Ultra Low Leakage..... $I_{D(OFF)}$ 200pA typical
- Low Capacitance..... cd 0.3pf typical
- Low ON Resistance..... 40 Ω typical
- TTL Compatible

APPLICATIONS

- Glitch-Free Analog Switches
- RF & Video Switches
- Sample-and-Hold Switches
- Communication Systems
- Disk Drives

DESCRIPTION

The Calogic CWB211 offers designers high performance at a low cost. The CWB211 is an excellent choice where capacitance and switching times are crucial. The device out performs industry standard DG211 types offering much faster switching speeds, low $R_{DS(ON)}$ and lower capacitance while maintaining high OFF isolation and good bandwidth. The Calogic CWB211 is configured to be a pin for pin replacement of existing analog switches and at the same time upgrading high frequency performance.

Manufactured on the Calogic proprietary low voltage CMOS combined with high speed DMOS FETs, the device is TTL compatible utilizing an on-chip reference to provide constant logic switching over a wide range of supply voltages and temperature without a separate power supply.

ORDERING INFORMATION

Part	Package	Temperature Range
CWB211CP	Plastic 16-Pin Dip	0 to +85°C
CWB211CY	SO-16 Plastic	0 to +85°C
XCWB211	Sorted Chips in Carriers	0 to +85°C

PIN CONFIGURATION

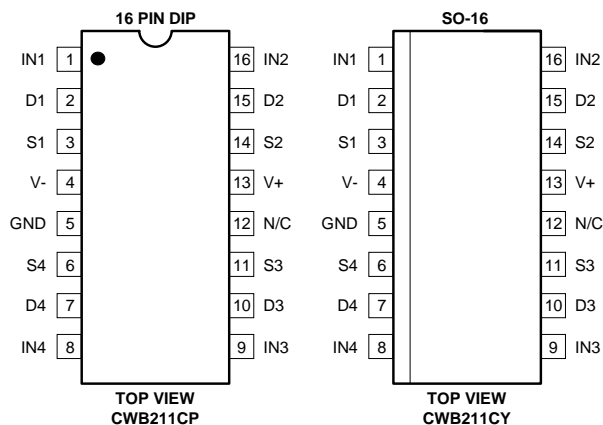

CWB

NOTE: All devices contain diodes to protect inputs against damage due to high static voltages or electric fields; however, it is advised that precautions be taken not to exceed the maximum recommended input voltages. All unused inputs must be connected to an appropriate logic level (V_{DD} or GND).

FUNCTIONAL BLOCK DIAGRAM

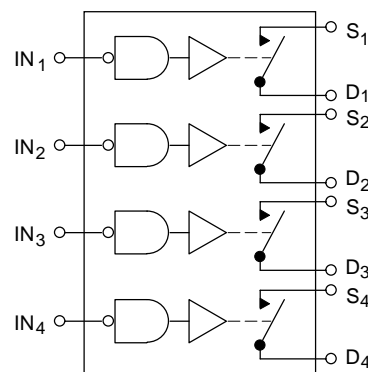

Four SPST Switches per Package.
Switches shown in Logic '1' Input Position.

LOGIC TABLE

Logic	Switch
0	ON
1	OFF

Logic '0' \leq 0.8V
Logic '1' \geq 2.42V

ABSOLUTE MAXIMUM RATINGS

V-	Negative Supply Voltage	-20V
V+	Positive Supply Voltage	+20V
V _{IN}	Control Input Voltage Range	V+ +0.3V V- -0.3V
I _L	Continuous Current, any Pin except S or D	20mA
I _S	Continuous Current, S or D	30mA
I _S	Peak Pulsed Current, S or D, 80μsec, 1%, Duty Cycle	90mA
T _J	Junction Temperature Range	-55 to +125°C
T _S	Storage Temperature Range	-55 to +125°C
P _D	Power Dissipation	500mW

RECOMMENDED OPERATING CONDITIONS

V-	Negative Supply Voltage	-8.0 to -15V
V+	Positive Supply Voltage	+8.0 to +15V
V _{IN}	Control Input Voltage Range	0 to +5V
T _{OP}	Operating Temperature	0 to +85°C

ELECTRICAL CHARACTERISTICS (V₋ = -15V, V₊ = +15V unless otherwise noted, T_A = +25°C)

SYMBOL	PARAMETER	MIN	TYP	MAX	UNITS	TEST CONDITIONS
STATIC						
V _{ANALOG}	Analog Signal Range	-10		+10	V	
r _{DS(ON)}	Channel ON Resistance		40	80	Ω	V _S = -10V V _S = +2.0V V _S = +10V V _{IN} = 0
			45	80		
			100	160		
V _{IH}	High Level Input Voltage	2.4			V	
V _{IL}	Low Level Input Voltage			0.8		
I _{IN}	Logic Input Leakage Current		0.01	0.1	μA	V _{IN} = +2.4V V _{IN} = +15V
			0.02	0.1		
I _{D(OFF)}	Switch OFF Leakage Current		0.2	5.0	nA	V _D = +10V, V _S = -10V V _S = +10V, V _D = -10V V _{IN} = +2.4V
I _{S(OFF)}			0.4	5.0		
I ₋	Negative Supply Quiescent Current		-0.3	-1.0	mA	V _{IN} = 0 or +2.4V
I ₊	Positive Supply Quiescent Current		0.6	2.0		
DYNAMIC						
t _{ON}	Switch Turn-ON Time		400	600	nsec	See Switching Times Test Circuit
t _{OFF}	Switch Turn-OFF Time		70	300		
O _{IRR}	OFF Isolation Rejection Ratio	60	66		dB	f = 10MHz, R _L = 50Ω
C _{CRR}	Cross Coupling Rejection Ratio		80			
C _d	Drain-Node Capacitance		0.3		pF	V _D = V _S = 0 f = 1MHz V _{IN} = +2.4V
C _s	Source-Node Capacitance		3.0			

ELECTRICAL CHARACTERISTICS (V₋ = -15V, V₊ = +15V unless otherwise noted)

LIMITS AT TEMPERATURE EXTREMES

SYMBOL	PARAMETER	MAXIMUM @ T _A =		UNITS	TEST CONDITIONS
		+85°C			
STATIC					
V _{ANALOG}	Analog Signal Range	±10		V	
r _{DS(ON)}	Switch ON Resistance	120		Ω	V _S = -10V V _S = +2.0V V _S = +10V V _{IN} = 0
		120			
		240			
I _{IN}	Logic Input Leakage Current	1.0		μA	V _{IN} = +2.4V V _{IN} = +15V
		2.0			
I _{D(OFF)}	Switch OFF Leakage Current	100		nA	V _D = +10V, V _S = -10V V _S = +10V, V _D = -10V V _{IN} = +2.4V
I _{S(OFF)}			100		
I ₋	Negative Supply Quiescent Current	-1.0		mA	V _{IN} = 0 or +2.4V
I ₊	Positive Supply Quiescent Current	2.0			

TYPICAL PERFORMANCE CHARACTERISTICS ($T_A = +25^\circ\text{C}$ unless otherwise specified)

SWITCHING TIMES TEST CIRCUIT

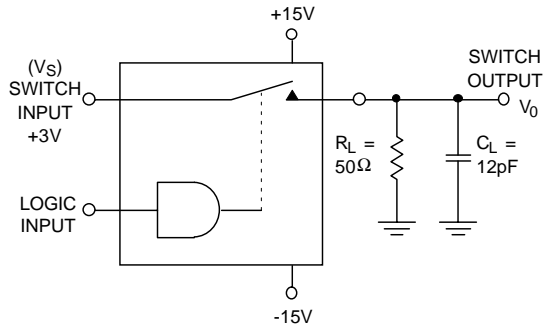

SWITCH ILLUSTRATED IN LOGIC '1', SWITCH OFF, POSITION

TEST WAVEFORMS

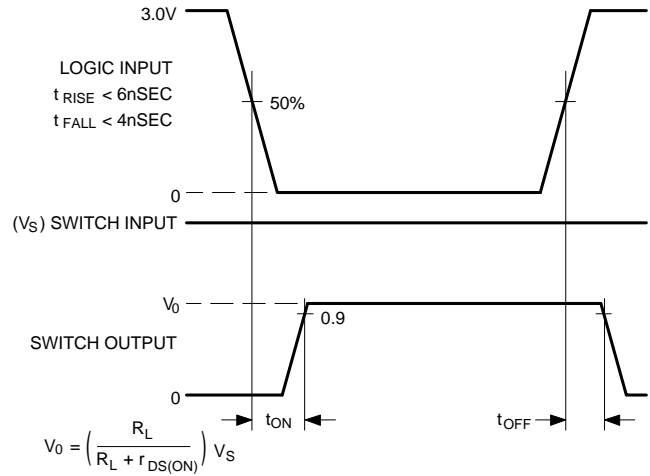

SWITCHING TIMES -VS- SUPPLY VOLTAGES

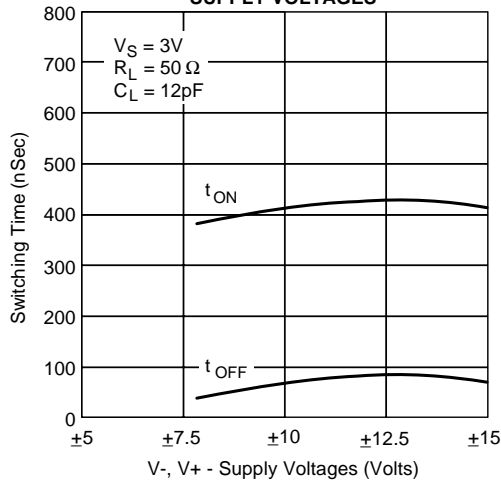

SWITCHING TIMES -VS- AMBIENT TEMPERATURE

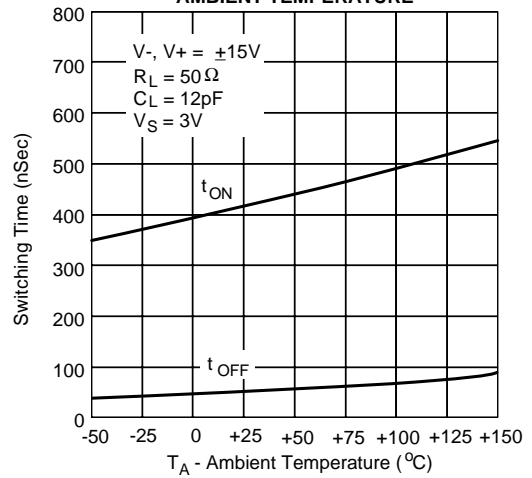

TYPICAL PERFORMANCE CHARACTERISTICS ($T_A = +25^\circ\text{C}$ unless otherwise specified)

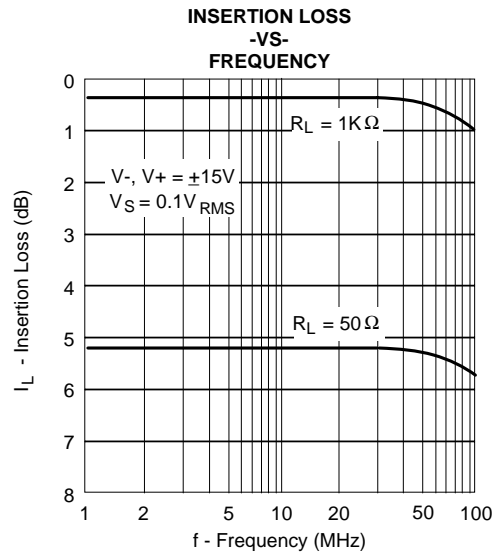
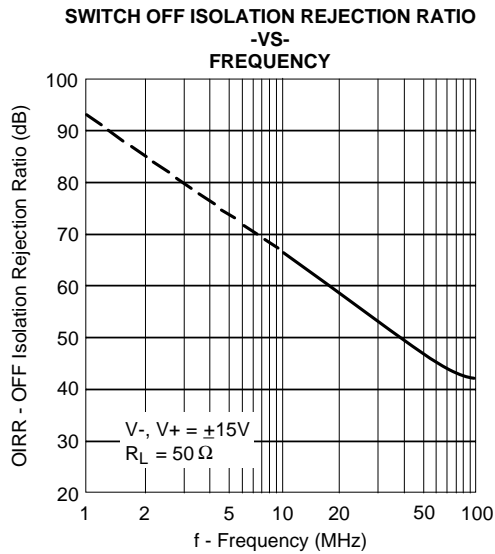
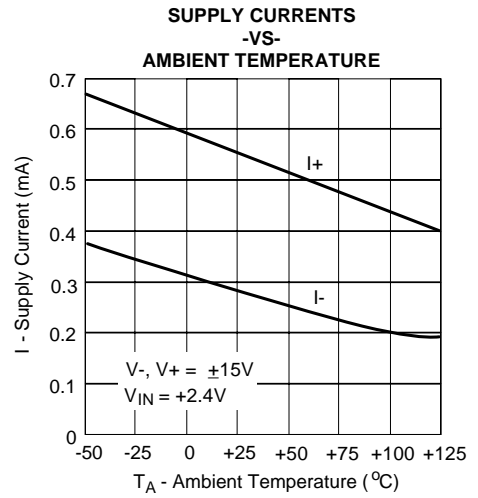
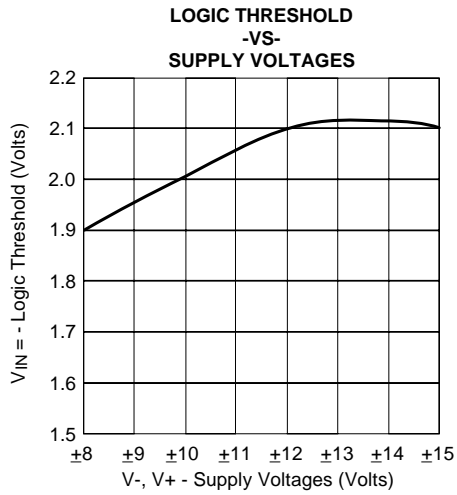

TYPICAL PERFORMANCE CHARACTERISTICS ($T_A = +25^\circ\text{C}$ unless otherwise specified)

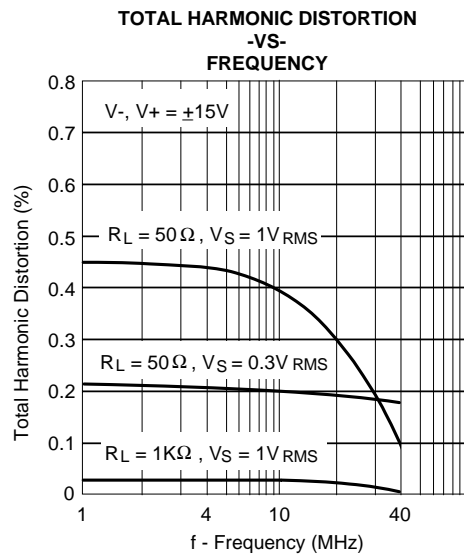
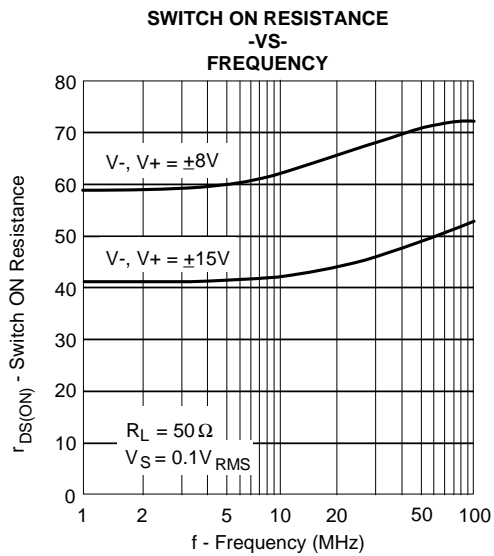
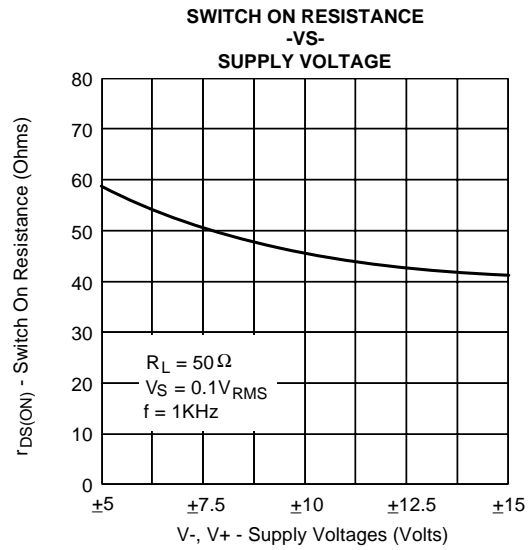
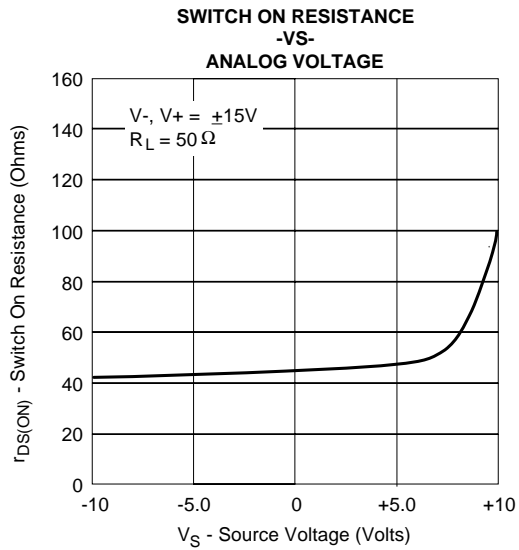



LittleDiode supplies new, hard to find or obsolete electronic components and semiconductors all over the world.

With over two million different components listed you are sure to find the part you need.

Feel free to visit us today at our online store:

LittleDiode.com

Looking forward to providing you with the best possible service.