

74ACQ657 • 74ACTQ657

Quiet Series™ Octal Bidirectional Transceiver with 8-Bit Parity Generator/Checker and 3-STATE Outputs

General Description

The ACQ/ACTQ657 contains eight non-inverting buffers with 3-STATE outputs and an 8-bit parity generator/checker. Intended for bus oriented applications, the device combines the 245 and the 280 functions in one package.

The ACQ/ACTQ utilizes Fairchild Quiet Series™ technology to guarantee quiet output switching and improved dynamic threshold performance. FACT Quiet Series features GTO™ output control and undershoot corrector in addition to a split ground bus or superior performance.

Features

- Guaranteed simultaneous switching noise level and dynamic threshold performance
- Guaranteed pin-to-pin skew AC performance
- Combines the 245 and the 280 functions in one package
- 300 mil 24-pin slim dual-in-line package
- Outputs source/sink 24 mA
- ACTQ has TTL-compatible inputs

Ordering Code:

Order Number	Package Number	Package Description
74ACQ657SPC	N24C	24-Lead Plastic Dual-In-Line Package (PDIP), JEDEC MS-001, 0.300 Wide
74ACTQ657SC	M24B	24-Lead Small Outline Integrated Circuit (SOIC), JEDEC MS-013, 0.300 Wide
74ACTQ657SPC	N24C	24-Lead Plastic Dual-In-Line Package (PDIP), JEDEC MS-001, 0.300 Wide

Device also available in Tape and Reel. Specify by appending suffix letter "X" to the ordering code

Logic Symbols

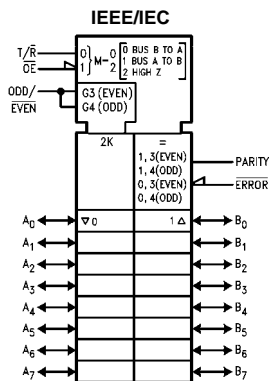

Connection Diagram

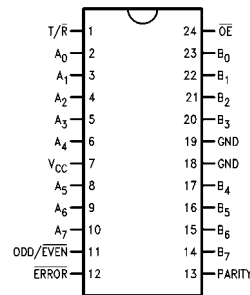

Pin Descriptions

Pin Names	Description
A ₀ -A ₇	Data Inputs/3-STATE Outputs
B ₀ -B ₇	Data Inputs/3-STATE Outputs
T/R	Transmit/Receive Input
OE	Enable Input
PARITY	Parity Input/3-STATE Output
ODD/EVEN	ODD/EVEN Parity Input
ERROR	Error 3-STATE Output

FACT™, Quiet Series™, FACT Quiet Series™, and GTO™ are trademarks of Fairchild Semiconductor Corporation.

74ACQ657 • 74ACTQ657 Quiet Series™ Octal Bidirectional Transceiver with 8-Bit Parity Generator/Checker and 3-STATE Outputs

Functional Description

The Transmit/Receive (T/\bar{R}) input determines the direction of the data flow through the bidirectional transceivers. Transmit (active HIGH) enables data from the A-Port to the B-Port; Receive (active LOW) enables data from the B-Port to the A-Port.

The Output Enable (\overline{OE}) input disables the parity and \overline{ERROR} outputs and both the A and B Ports by placing them in a HIGH-Z condition when the Output Enable input is HIGH.

When transmitting (T/\bar{R} HIGH), the parity generator detects whether an even or odd number of bits on the A-Port are HIGH and compares these with the condition of the parity

select (ODD/\overline{EVEN}). If the Parity Select is HIGH and an even number of A inputs are HIGH, the Parity output is HIGH.

In receiving mode (T/\bar{R} LOW), the parity select and number of HIGH inputs on port B are compared to the condition of the Parity input. If an even number of bits on the B-Port are HIGH, the parity select is HIGH, and the PARITY input is HIGH, then \overline{ERROR} will be HIGH to indicate no error. If an odd number of bits on the B-Port are HIGH, the parity select is HIGH, and the PARITY input is HIGH, the \overline{ERROR} will be LOW indicating an error.

Function Table

Number of Inputs That Are High	Inputs			Input/Output	Outputs	
	\overline{OE}	T/\bar{R}	ODD/\overline{EVEN}	Parity	\overline{ERROR}	Outputs Mode
0, 2, 4, 6, 8	L	H	H	H	Z	Transmit
	L	H	L	L	Z	Transmit
	L	L	H	H	H	Receive
	L	L	H	L	L	Receive
	L	L	L	H	L	Receive
	L	L	L	L	L	Receive
1, 3, 5, 7	L	H	H	L	Z	Transmit
	L	H	L	H	Z	Transmit
	L	L	H	H	L	Receive
	L	L	H	L	H	Receive
	L	L	L	H	H	Receive
	L	L	L	L	L	Receive
Immaterial	H	X	X	Z	Z	Z

H = HIGH Voltage Level
L = LOW Voltage Level
X = Immaterial
Z = High Impedance

Function Table

Inputs		Outputs
\overline{OE}	T/\bar{R}	
L	L	Bus B Data to Bus A
L	H	Bus A Data to Bus B
H	X	High-Z State

H = HIGH Voltage Level
L = LOW Voltage Level
X = Immaterial

Functional Block Diagram

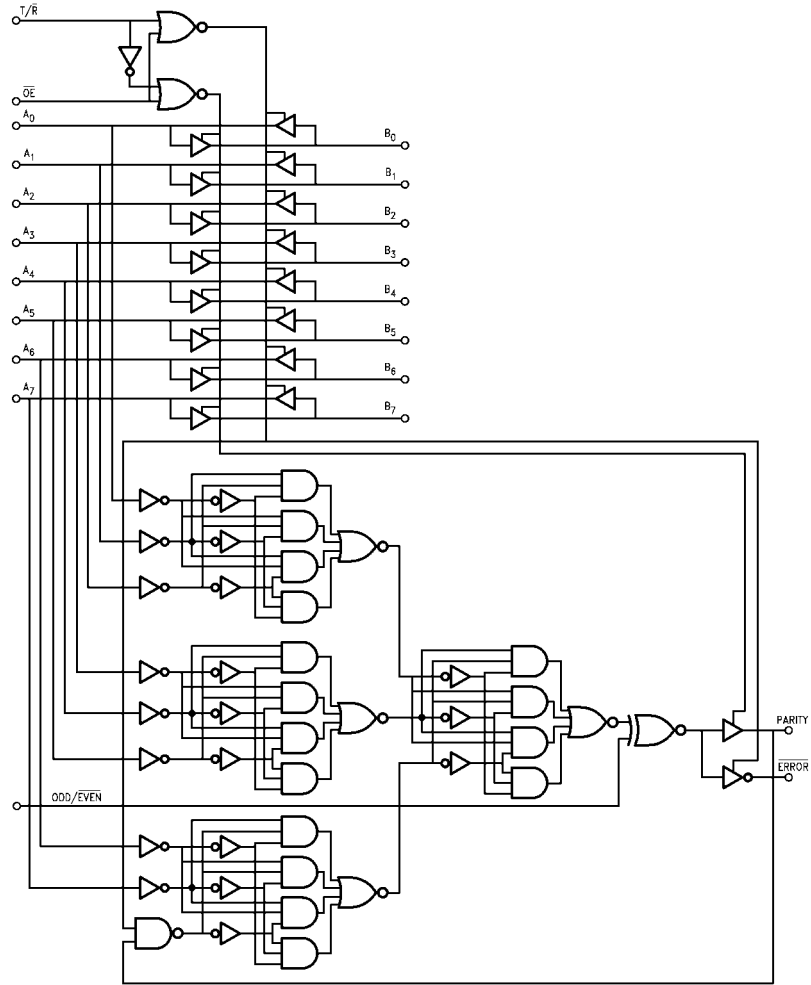

2 GROUND PINS
1 V_{CC} PIN

Please note that this diagram is provided only for the understanding of logic operations and should not be used to estimate propagation delays.

Absolute Maximum Ratings(Note 1)

Supply Voltage (V_{CC})	-0.5V to +7.0V
DC Input Diode Current (I_{IK})	
$V_I = -0.5V$	-20 mA
$V_I = V_{CC} + 0.5V$	+20 mA
DC Input Voltage (V_I)	-0.5V to $V_{CC} + 0.5V$
DC Output Diode Current (I_{OK})	
$V_O = -0.5V$	-20 mA
$V_O = V_{CC} + 0.5V$	+20 mA
DC Output Voltage (V_O)	-0.5V to $V_{CC} + 0.5V$
DC Output Source	
or Sink Current (I_O)	± 50 mA
DC V_{CC} or Ground Current	
per Output Pin (I_{CC} or I_{GND})	± 50 mA
Storage Temperature (T_{STG})	-65°C to +150°C
DC Latch-up Source	
Sink Current	± 300 mA
Junction Temperature (T_J)	
PDIP	140°C

Recommended Operating Conditions

Supply Voltage (V_{CC})	
ACQ	2.0V to 6.0V
ACTQ	4.5V to 5.5V
Input Voltage (V_I)	0V to V_{CC}
Output Voltage (V_O)	0V to V_{CC}
Operating Temperature (T_A)	-40°C to +85°C
Minimum Input Edge Rate $\Delta V/\Delta t$	
ACQ Devices	
V_{IN} from 30% to 70% of V_{CC}	
V_{CC} @ 3.0V, 4.5V, 5.5V	125 mV/ns
Minimum Input Edge Rate $\Delta V/\Delta t$	
ACTQ Devices	
V_{IN} from 0.8V to 2.0V	
V_{CC} @ 4.5V, 5.5V	125 mV/ns

Note 1: Absolute maximum ratings are those values beyond which damage to the device may occur. The databook specifications should be met, with-out exception, to ensure that the system design is reliable over its power supply, temperature, and output/input loading variables. Fairchild does not recommend operation of FACT™ circuits outside databook specifications.

DC Electrical Characteristics for ACQ

Symbol	Parameter	V_{CC} (V)	$T_A = +25^\circ\text{C}$		$T_A = -40^\circ\text{C to } +85^\circ\text{C}$		Units	Conditions
			Typ	Guaranteed Limits	Typ	Guaranteed Limits		
V_{IH}	Minimum HIGH Level Input Voltage	3.0	1.5	2.1	2.1		V	$V_{OUT} = 0.1V$ or $V_{CC} - 0.1V$
		4.5	2.25	3.15	3.15			
		5.5	2.75	3.85	3.85			
V_{IL}	Maximum LOW Level Input Voltage	3.0	1.5	0.9	0.9		V	$V_{OUT} = 0.1V$ or $V_{CC} - 0.1V$
		4.5	2.25	1.35	1.35			
		5.5	2.75	1.65	1.65			
V_{OH}	Minimum HIGH Level Voltage Output	3.0	2.99	2.9	2.9		V	$I_{OUT} = -50 \mu\text{A}$
		4.5	4.49	4.4	4.4			
		5.5	5.49	5.4	5.4			
		3.0		2.56	2.46		V	$V_{IN} = V_{IL}$ or V_{IH} $I_{OH} = -12 \text{ mA}$ $I_{OH} = -24 \text{ mA}$ $I_{OH} = -24 \text{ mA (Note 2)}$
		4.5		3.86	3.76			
		5.5		4.85	4.76			
V_{OL}	Maximum LOW Level Output Voltage	3.0	0.002	0.1	0.1		V	$I_{OUT} = 50 \mu\text{A}$
		4.5	0.001	0.1	0.1			
		5.5	0.001	0.1	0.1			
		3.0		0.36	0.44		V	$V_{IN} = V_{IL}$ or V_{IH} $I_{OL} = 12 \text{ mA}$ $I_{OL} = 24 \text{ mA}$ $I_{OL} = 24 \text{ mA (Note 2)}$
		4.5		0.36	0.44			
		5.5		0.36	0.44			
I_{IN} (Note 4)	Maximum Input Leakage Current (T/R, OE, ODD/EVEN Inputs)	5.5		± 0.1	± 1.0		μA	$V_I = V_{CC}, \text{ GND}$
I_{OLD}	Minimum Dynamic	5.5			75		mA	$V_{OLD} = 1.65V \text{ Max}$
I_{OHD}	Output Current (Note 3)	5.5			-75		mA	$V_{OHD} = 3.85V \text{ Min}$
I_{CC} (Note 4)	Maximum Quiescent Supply Current	5.5		8.0	80.0		μA	$V_{IN} = V_{CC}$ or GND
I_{OZT}	Maximum I/O Leakage Current (A_n, B_n Inputs)	5.5		± 0.6	± 6.0		μA	V_I (OE) = V_{IL}, V_{IH} $V_I = V_{CC}, \text{ GND}$ $V_O = V_{CC}, \text{ GND}$
V_{OLP}	Quiet Output Maximum Dynamic V_{OL}	5.0	1.1	1.5			V	Figures 1, 2 (Note 5)(Note 6)

DC Electrical Characteristics for ACQ (Continued)

Symbol	Parameter	V _{CC} (V)	T _A = +25°C		T _A = -40°C to +85°C	Units	Conditions
			Typ	Guaranteed Limits			
V _{OLV}	Quiet Output Minimum Dynamic V _{OL}	5.0	-0.6	-1.2		V	Figures 1, 2 (Note 5)(Note 6)
V _{IHD}	Minimum HIGH Level Dynamic Input Voltage	5.0	3.1	3.5		V	(Note 5)(Note 7)
V _{ILD}	Maximum LOW Level Dynamic Input Voltage	5.0	1.9	1.5		V	(Note 5)(Note 7)

Note 2: Maximum of 8 outputs loaded; thresholds on input associated with output under test.

Note 3: Maximum test duration 2.0 ms, one output loaded at a time.

Note 4: I_{IN} and I_{CC} @ 3.0V are guaranteed to be less than or equal to the respective limit @ 5.5V V_{CC}.

Note 5: DIP package.

Note 6: Max number of outputs defined as (n). Data Inputs are driven 0V to 5V. One output @ GND.

Note 7: Max number of Data Inputs (n) switching. (n-1) Inputs switching 0V to 5V (ACQ). Input-under-test switching: 5V to threshold (V_{ILD}), 0V to threshold (V_{IHD}) f = 1 MHz.

DC Electrical Characteristics for ACTQ

Symbol	Parameter	V _{CC} (V)	T _A = +25°C		T _A = -40°C to +85°C	Units	Conditions
			Typ	Guaranteed Limits			
V _{IH}	Minimum HIGH Level Input Voltage	4.5	1.5	2.0	2.0	V	V _{OUT} = 0.1V or V _{CC} - 0.1V
		5.5	1.5	2.0	2.0		
V _{IL}	Maximum LOW Level Input Voltage	4.5	1.5	0.8	0.8	V	V _{OUT} = 0.1V or V _{CC} - 0.1V
		5.5	1.5	0.8	0.8		
V _{OH}	Minimum HIGH Level Output Voltage	4.5	4.49	4.4	4.4	V	I _{OUT} = -50 μA
		5.5	5.49	5.4	5.4		
		4.5		3.86	3.76	V	V _{IN} = V _{IL} or V _{IH} I _{OH} = -24mA I _{OH} = -24 mA (Note 8)
		5.5		4.86	4.76		
V _{OL}	Maximum LOW Level Output Voltage	4.5	0.001	0.1	0.1	V	I _{OUT} = 50 μA
		5.5	0.001	0.1	0.1		
		4.5		0.36	0.44	V	V _{IN} = V _{IL} or V _{IH} I _{OL} = 24 mA I _{OL} = 24 mA (Note 8)
		5.5		0.36	0.44		
I _{IN}	Maximum Input Leakage Current (T/R, OE, ODD/EVEN Inputs)	5.5		±0.1	±1.0	μA	V _I = V _{CC} , GND
I _{OZT}	Maximum I/O Leakage Current (A _n , B _n Inputs)	5.5		±0.6	±6.0	μA	V _I = V _{IL} , V _{IH} V _O = V _{CC} , GND
		5.5					
I _{CCT}	Maximum I _{CC} /Input	5.5	0.6		1.5	mA	V _I = V _{CC} - 2.1V
I _{OLD}	Minimum Dynamic	5.5			75	mA	V _{OLD} = 1.65V Max
I _{OHD}	Output Current (Note 9)	5.5			-75	mA	V _{OHD} = 3.85V Min
I _{CC} (Note 4)	Maximum Quiescent Supply Current	5.5		8.0	80.0	μA	V _{IN} = V _{CC} or GND
V _{OLP}	Quiet Output Maximum Dynamic V _{OL}	5.0	1.1	1.5		V	Figures 1, 2 (Note 10)(Note 11)
V _{OLV}	Quiet Output Minimum Dynamic V _{OL}	5.0	-0.6	-1.2		V	Figures 1, 2 (Note 10)(Note 11)
V _{IHD}	Minimum HIGH Level Dynamic Input Voltage	5.0	1.9	2.2		V	(Note 10)(Note 12)
V _{ILD}	Maximum LOW Level Dynamic Input Voltage	5.0	1.2	0.8		V	(Note 10)(Note 12)

Note 8: All outputs loaded; thresholds on input associated with output under test.

Note 9: Maximum test duration 2.0 ms, one output loaded at a time.

Note 10: DIP package.

Note 11: Max number of outputs defined as (n). n-1 Data Inputs are driven 0V to 3V; one output @ GND.

Note 12: Max number of Data Inputs (n) switching. (n-1) Inputs switching 0V to 3V (ACQ). Input-under-test switching: 3V to threshold (V_{ILD}), 0V to threshold (V_{IHD}) f = 1 MHz.

AC Electrical Characteristics for ACQ								
Symbol	Parameter	V _{CC} (V) (Note 13)	T _A = 25°C C _L = 50 pF			T _A = -40°C to +85°C C _L = 50 pF		Units
			Min	Typ	Max	Min	Max	
t _{PLH}	Propagation Delay	3.3	2.5	8.0	11.5	2.5	12.0	ns
t _{PHL}	A _n to B _n , B _n to A _n	5.0	1.5	5.0	7.5	1.5	8.0	
t _{PLH}	Propagation Delay	3.3	3.0	11.5	16.5	3.0	17.0	ns
t _{PHL}	A _n to PARITY	5.0	2.0	7.0	10.5	2.0	11.0	
t _{PLH}	Propagation Delay	3.3	3.0	10.0	15.0	3.0	15.5	ns
t _{PHL}	ODD/EVEN to PARITY	5.0	2.5	6.5	10.0	2.5	10.5	
t _{PLH}	Propagation Delay	3.3	3.0	10.0	15.0	3.0	15.5	ns
t _{PHL}	ODD/EVEN to ERROR	5.0	2.5	6.5	10.0	2.5	10.5	
t _{PLH}	Propagation Delay	3.3	3.5	11.5	16.0	3.5	16.5	ns
t _{PHL}	B _n to ERROR	5.0	2.5	7.0	10.5	2.5	11.0	
t _{PLH}	Propagation Delay	3.3	3.0	9.0	13.5	3.0	14.0	ns
t _{PHL}	PARITY to ERROR	5.0	2.0	6.0	9.0	2.0	9.5	
t _{PZH}	Output Enable Time	3.3	2.5	9.0	13.5	2.5	14.0	ns
t _{PZL}	\overline{OE} to A _n /B _n	5.0	2.0	6.0	9.0	2.0	9.5	
t _{PHZ}	Output Disable Time	3.3	1.0	8.5	13.0	1.0	13.5	ns
t _{PLZ}	\overline{OE} to A _n /B _n	5.0	1.0	5.5	8.5	1.0	9.0	
t _{PZH}	Output Enable Time	3.3	2.5	9.0	13.5	2.5	14.0	ns
t _{PZL}	\overline{OE} to ERROR (Note 15)	5.0	2.0	6.0	9.0	2.0	9.5	
t _{PHZ}	Output Disable Time	3.3	1.0	8.5	13.0	1.0	13.5	ns
t _{PLZ}	\overline{OE} to ERROR	5.0	1.0	5.5	8.5	1.0	9.0	
t _{PZH}	Output Enable Time	3.3	2.5	9.0	13.5	2.5	14.0	ns
t _{PZL}	\overline{OE} to PARITY	5.0	2.0	6.0	9.0	2.0	9.5	
t _{PHZ}	Output Disable Time	3.3	1.0	8.5	13.0	1.0	13.5	ns
t _{PLZ}	\overline{OE} to PARITY	5.0	1.0	5.5	8.5	1.0	9.0	
t _{OSSL}	Output to Output Skew (Note 14)	3.3		1.0	1.5		1.5	ns
t _{OSLH}	A _n , B _n to B _n , A _n	5.0		0.5	1.0		1.0	

Note 13: Voltage Range 3.3 is 3.3V ± 0.3V
Voltage Range 5.0 is 5.0V ± 0.5V

Note 14: Skew is defined as the absolute value of the difference between the actual propagation delay for any two outputs within the same packaged device. The specification applies to any outputs switching in the same direction, either HIGH-to-LOW (t_{OSSL}) or LOW-to-HIGH (t_{OSLH}). Parameter guaranteed by design. Not tested.

Note 15: These delay times reflect the 3-STATE recovery time only and not the signal time through the buffers or the parity check circuitry. To assure VALID information at the ERROR pin, time must be allowed for the signal to propagate through the drivers (B to A), through the parity check circuitry (same as A to PARITY), and to the ERROR output after the ERROR pin has been enabled (Output Enable times). VALID data at the ERROR pin ≥ (A to PARITY) + (Output Enable Time).

AC Electrical Characteristics for ACTQ								
Symbol	Parameter	V _{CC} (V) (Note 16)	T _A = 25°C C _L = 50 pF			T _A = -40°C to +85°C C _L = 50 pF		Units
			Min	Typ	Max	Min	Max	
t _{PLH} t _{PHL}	Propagation Delay A _n to B _n , B _n to A _n	5.0	1.5	5.0	8.0	1.5	8.5	ns
t _{PLH} t _{PHL}	Propagation Delay A _n to Parity	5.0	2.5	7.5	11.0	2.5	11.5	ns
t _{PLH} t _{PHL}	Propagation Delay ODD/EVEN to PARITY	5.0	2.5	6.5	10.5	2.5	11.0	ns
t _{PLH} t _{PHL}	Propagation Delay ODD/EVEN to ERROR	5.0	2.5	6.5	10.5	2.5	11.0	ns
t _{PLH} t _{PHL}	Propagation Delay B _n to ERROR	5.0	3.0	7.5	11.0	3.0	11.5	ns
t _{PLH} t _{PHL}	Propagation Delay PARITY to ERROR	5.0	2.0	6.0	9.5	2.0	10.0	ns
t _{PZH} t _{PZL}	Output Enable Time OE to A _n /B _n	5.0	2.0	6.0	9.5	2.0	10.0	ns
t _{PHZ} t _{PLZ}	Output Disable Time OE to A _n /B _n	5.0	1.0	5.0	9.0	1.0	9.5	ns
t _{PZH} t _{PZL}	Output Enable Time OE to ERROR (Note 18)	5.0	2.0	6.0	9.5	2.0	10.0	ns
t _{PHZ} t _{PLZ}	Output Disable Time OE to ERROR	5.0	1.0	6.0	9.0	1.0	9.5	ns
t _{PZH} t _{PZL}	Output Enable Time OE to PARITY	5.0	2.0	6.0	9.5	2.0	10.0	ns
t _{PHZ} t _{PLZ}	Output Disable Time OE to PARITY	5.0	1.0	5.0	9.0	1.0	9.5	ns
t _{OSSL} t _{OSLH}	Output to Output Skew A _n , B _n to B _n , A _n (Note 17)	5.0		0.5	1.0		1.0	ns

Note 16: Voltage Range 5.0 is 5.0V ±0.5V

Note 17: Skew is defined as the absolute value of the difference between the actual propagation delay for any two outputs within the same packaged device. The specification applies to any outputs switching in the same direction, either HIGH-to-LOW (t_{OSSL}) or LOW-to-HIGH (t_{OSLH}). Parameter guaranteed by design. Not tested.

Note 18: These delay times reflect the 3-STATE recovery time only and not the signal time through the buffers or the parity check circuitry. To assure VALID information at the ERROR pin, time must be allowed for the signal to propagate through the drivers (B to A), through the parity check circuitry (same as A to PARITY), and to the ERROR output after the ERROR pin has been enabled (Output Enable times). VALID data at the ERROR pin ≥ (A to PARITY) + (Output Enable Time).

Capacitance

Symbol	Parameter	Typ	Units	Conditions
C _{IN}	Input Capacitance	4.5	pF	V _{CC} = 5.0V
C _{PD}	Power Dissipation Capacitance	160.0	pF	V _{CC} = 5.0

FACT Noise Characteristics

The setup of a noise characteristics measurement is critical to the accuracy and repeatability of the tests. The following is a brief description of the setup used to measure the noise characteristics of FACT.

Equipment:

Hewlett Packard Model 8180A Word Generator
PC-163A Test Fixture
Tektronics Model 7854 Oscilloscope

Procedure:

1. Verify Test Fixture Loading: Standard Load 50 pF, 500Ω.
2. Deskew the HFS generator so that no two channels have greater than 150 ps skew between them. This requires that the oscilloscope be deskewed first. It is important to deskew the HFS generator channels before testing. This will ensure that the outputs switch simultaneously.
3. Terminate all inputs and outputs to ensure proper loading of the outputs and that the input levels are at the correct voltage.
4. Set the HFS generator to toggle all but one output at a frequency of 1 MHz. Greater frequencies will increase DUT heating and effect the results of the measurement.
5. Set the HFS generator input levels at 0V LOW and 3V HIGH for ACT devices and 0V LOW and 5V HIGH for AC devices. Verify levels with an oscilloscope.

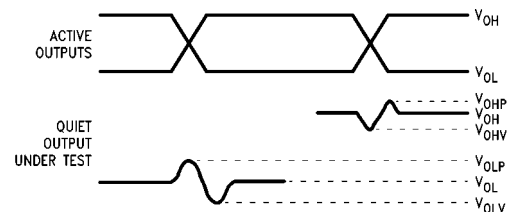

FIGURE 1. Quiet Output Noise Voltage Waveforms

Note 19: V_{OHV} and V_{OLP} are measured with respect to ground reference.

Note 20: Input pulses have the following characteristics: $f = 1$ MHz, $t_r = 3$ ns, $t_f = 3$ ns, skew < 150 ps.

V_{OLP}/V_{OLV} and V_{OHP}/V_{OHV} :

- Determine the quiet output pin that demonstrates the greatest noise levels. The worst case pin will usually be the furthest from the ground pin. Monitor the output voltages using a 50Ω coaxial cable plugged into a standard SMB type connector on the test fixture. Do not use an active FET probe.
- Measure V_{OLP} and V_{OLV} on the quiet output during the worst case transition for active and enable. Measure V_{OHP} and V_{OHV} on the quiet output during the worst case transition.
- Verify that the GND reference recorded on the oscilloscope has not drifted to ensure the accuracy and repeatability of the measurements.

V_{ILD} and V_{IHD} :

- Monitor one of the switching outputs using a 50Ω coaxial cable plugged into a standard SMB type connector on the test fixture. Do not use an active FET probe.
- First increase the input LOW voltage level, V_{IL} , until the output begins to oscillate or steps out a min of 2 ns. Oscillation is defined as noise on the output LOW level that exceeds V_{IL} limits, or on output HIGH levels that exceed V_{IH} limits. The input LOW voltage level at which oscillation occurs is defined as V_{ILD} .
- Next decrease the input HIGH voltage level, V_{IH} , until the output begins to oscillate or steps out a min of 2 ns. Oscillation is defined as noise on the output LOW level that exceeds V_{IL} limits, or on output HIGH levels that exceed V_{IH} limits. The input HIGH voltage level at which oscillation occurs is defined as V_{IHD} .
- Verify that the GND reference recorded on the oscilloscope has not drifted to ensure the accuracy and repeatability of the measurements.

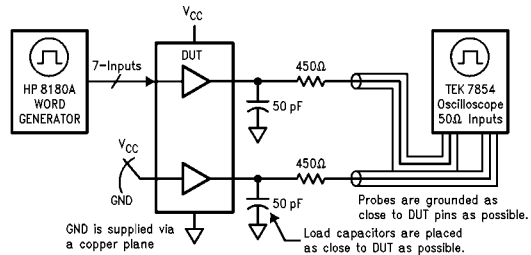
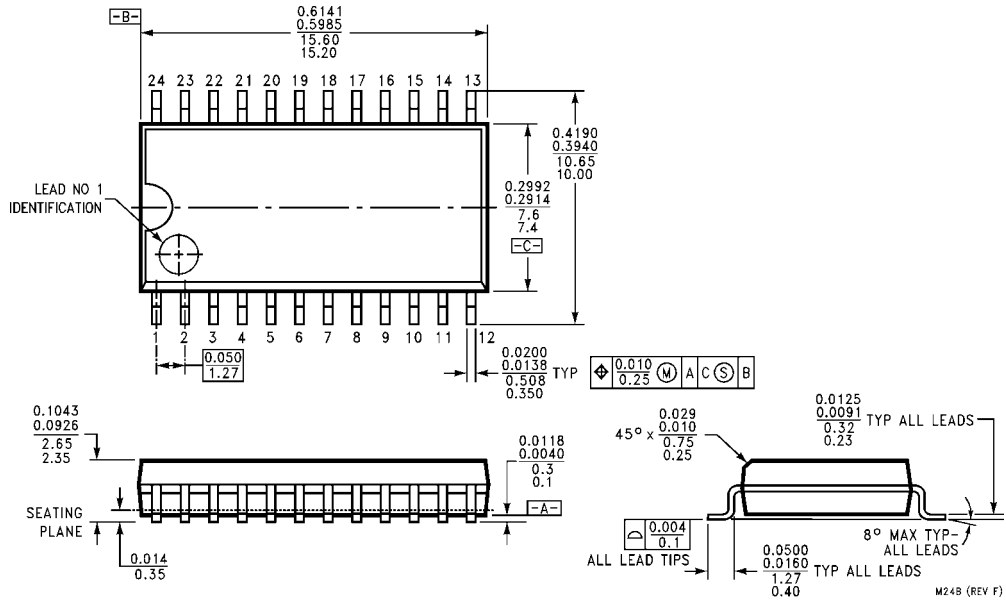

FIGURE 2. Simultaneous Switching Test Circuit

Physical Dimensions inches (millimeters) unless otherwise noted



**24-Lead Small Outline Integrated Circuit (SOIC), JEDEC MS-013, 0.300 Wide
Package Number M24B**

Physical Dimensions inches (millimeters) unless otherwise noted (Continued)

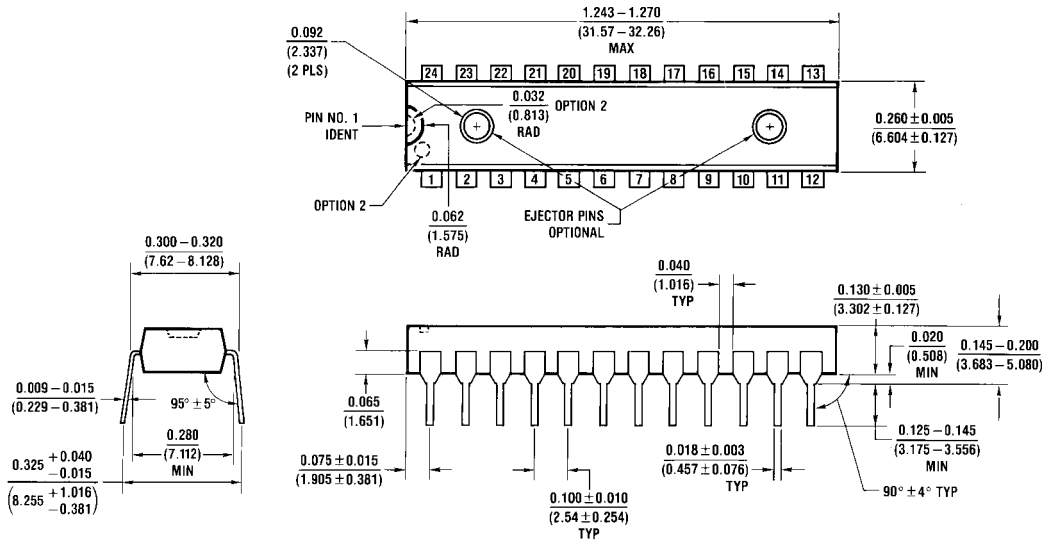

24-Lead Plastic Dual-In-Line Package (PDIP), JEDEC MS-001, 0.300 Wide Package Number N24C

Fairchild does not assume any responsibility for use of any circuitry described, no circuit patent licenses are implied and Fairchild reserves the right at any time without notice to change said circuitry and specifications.

LIFE SUPPORT POLICY

FAIRCHILD'S PRODUCTS ARE NOT AUTHORIZED FOR USE AS CRITICAL COMPONENTS IN LIFE SUPPORT DEVICES OR SYSTEMS WITHOUT THE EXPRESS WRITTEN APPROVAL OF THE PRESIDENT OF FAIRCHILD SEMICONDUCTOR CORPORATION. As used herein:

1. Life support devices or systems are devices or systems which, (a) are intended for surgical implant into the body, or (b) support or sustain life, and (c) whose failure to perform when properly used in accordance with instructions for use provided in the labeling, can be reasonably expected to result in a significant injury to the user.
2. A critical component in any component of a life support device or system whose failure to perform can be reasonably expected to cause the failure of the life support device or system, or to affect its safety or effectiveness.

www.fairchildsemi.com

This datasheet has been downloaded from:

www.DatasheetCatalog.com

Datasheets for electronic components.

National Semiconductor was acquired by Texas Instruments.

http://www.ti.com/corp/docs/investor_relations/pr_09_23_2011_national_semiconductor.html

This file is the datasheet for the following electronic components:

74ACQ821L - <http://www.ti.com/product/74acq821l?HQS=TI-null-null-dscatalog-df-pf-null-ww>



LittleDiode supplies new, hard to find or obsolete electronic components and semiconductors all over the world.

With over two million different components listed you are sure to find the part you need.

Feel free to visit us today at our online store:

LittleDiode.com

Looking forward to providing you with the best possible service.